



Nextreme™ Compressor-based Recirculating Chillers

Specification and User Manual

www.lairdthermal.com

Any information furnished by Laird and its agents, whether in specifications, data sheets, product catalogues or otherwise, is believed to be (but is not warranted as being) accurate and reliable, is provided for information only and does not form part of any contract with Laird. All specifications are subject to change without notice. Laird assumes no responsibility and disclaims all liability for losses or damages resulting from use of or reliance on this information. All Laird products are sold subject to the Laird Terms and Conditions of sale (including Laird's limited warranty) in effect from time to time, a copy of which will be furnished upon request.

Trademarks

© Copyright 2020-2021 Laird Thermal Systems, Inc. All rights reserved. Laird™, the Laird Ring Logo, and Laird Thermal Systems™ are trademarks or registered trademarks of Laird Limited or its subsidiaries. Nextreme™ is a trademark of Laird Thermal Systems, Inc. All other marks are owned by their respective owners.

Table of Contents

Revision History	6
Introduction	7
Safety Precautions	8
Guidelines for Safe Operation	8
Prevent Hazards	8
Personal Protective Gear	8
Guidelines Regarding Electrical Equipment	9
Inadmissible Operating Conditions	9
Specialized Knowledge	9
Safety and Signaling Equipment Included in the Unit	10
Guards	11
In Case of Accidents	11
Model Number Description	13
Specifications	14
Component Locations	17
Labels and Markings	19
Optional System Features	20
Coolant Filter Kit	20
Flow Control Kit	21
Flow Control Kit with Filter	24
Transport, Packaging and Storage	26
Safety	26
Checking the Delivery Condition	26
Symbols on the Packaging	26
Packaging	27
Unpacking	27
Handling the Unit While in the Packaging	29
Transportation on casters	30
Storing the Unit	30
Preparing the Unit for Further Transport	30
Installation Requirements	32
Installation Procedure	33
Connect Hoses	33
Disconnect Hoses	34
Connecting Power	35
Adding Coolant and Priming Unit	35
Chiller Operation	38
Plumbing & Refrigeration Diagram	40
Performance Graphs	41
Thermal Performance	41

Pump Performance	42
Chiller Dimensions.....	43
Controller Display Panel Functions	45
Startup Screen	45
Main Screen	45
Running the Pump	46
Choosing the Coolant Setpoint	46
Running the system	46
Sleep Screen.....	47
Information Screen	47
Alarms Display Screen.....	48
Acknowledging Alarms	48
Settings Screen	49
Setting Units	49
Choosing the Coolant.....	49
Customer Configurable Alarms	50
Flow Settings.....	51
Troubleshooting.....	53
Alarms	54
Communications Interface	58
Instructions for Setup	58
Commands and responses:	58
Command entry format	58
Source ID	58
Command Structure Examples	58
System Maintenance and Service	59
Safety	59
Maintenance Schedule.....	60
Preparing the Unit for Maintenance	61
Verification of Safe State after Maintenance.....	61
Draining Procedure	61
Coolant Maintenance	62
Replace filter	62
Cleaning the Heat Exchanger	62
Spare Parts	64
Decommissioning and Disposal.....	67
Temporarily Placing Out of Operation.....	67
Returning the Unit to Service After Decommissioning	67
Final Decommissioning or Disposal	67
Disposal of Operating Materials	67
Disposal of Refrigerant.....	68

Return of the Unit to Laird Thermal Systems	68
Return Procedure	69
List of figures	70

Revision History

User Manual Part number: 387004848

REV	DATE	DESCRIPTION
00	05/21/2020	Initial release
01	09/28/2020	Updated Return Procedure, Copyright statement, added Product Trademark
02	03/11/2021	Removed SC1 and SC2 options. Updated commands and responses under communication interface section, bill of materials and images for optional kits, alarms table, maximum pump pressure rating, cooling capacity and electrical input specification for all the models, spare parts lists.
03	10/27/2021	Updated cover, added power cord options table, removed CE Declaration of Conformity

Introduction

The Nextreme™ Recirculating Chiller is a refrigeration-based chiller designed for precise and reliable temperature control of equipment. It can be used in several user applications such as Medical, Analytical Instrumentation, Industrial and Semiconductor. This family of chillers offer different configurable options for pumps selection, coolant flow control, supply pressure monitoring and filtering. This chiller also uses a semi-closed system for low coolant maintenance.

This user manual provides necessary information to the customer for proper installation, operation, communication and maintenance of the chiller.

Safety Precautions

This section provides an overview of all the important safety aspects for optimal protection of personnel as well as safe and trouble-free operation of the equipment.

The operating manual and warning instructions specified herein should be reviewed completely by all personnel prior to operating the unit. Disregarding instructions within this manual may result in considerable danger.

Guidelines for Safe Operation

Prevent Hazards

Hazards can be prevented by safety-conscious and anticipatory behavior of staff. Individuals working with the unit should keep the following in mind:

- Always keep a complete and legible copy of this operating manual (or the location at which it can be found) available at the installation site of the unit.
- Use personal protection equipment.
- Unit personnel must be familiar with all operating elements of the unit before starting work on the unit.
- Only use the unit for its intended purpose.
- Conduct inspections on a regular basis and ensure the unit is operational and free of damage.
- All unit warning and information signs must be kept in legible condition. If a warning or information sign is lost or illegible, it must be replaced.
- Unit repairs may be carried out by qualified personnel only.
- Any disruption or recognizable change concerning the unit should be reported to the responsible person.
- Adhere to the accident prevention regulations as well as any regional regulations.

Personal Protective Gear

To minimize health hazards, wearing personal protective gear is required when handling the unit. The following personal protective gear must always be worn when handling the unit:



Protective footwear
For protection from falling parts and to prevent slipping.

When cleaning or performing maintenance or repair work on the unit, the following specific personal protective gear is required:



Protective gloves
To protect the hands from rubbing, abrasions, cuts, or more serious injuries. To prevent burns when touching hot coolant.



Protective eyewear
To protect the eyes against flying parts or splashing coolant.

Guidelines Regarding Electrical Equipment



DANGER



Electrical danger

Work on electrical installations must be carried out only by trained and authorized electricians.

- Observe all regional regulations when connecting electrical equipment to mains.
- Electrical shock hazards exist if the electrical installations are defective, or the insulation fails during operation.
- Switch off and disconnect the unit from the electrical mains and follow Lockout-Tagout procedures whenever conducting service work.
- Ensure continuity to ground and isolation from power lines.
- Any changes in the operation of the unit can have an influence on safe operation. All intended changes should be authorized by the manufacturer prior to implementation.
- Keep unauthorized persons away from the working area.
- This unit complies with surge protection standard IEC61000-4-5:2014. If the unit is installed in areas where power surges could exceed the limits in this standard, suitable surge protection devices must be installed to protect the unit.

Inadmissible Operating Conditions

Operating the unit under improper conditions is not permitted as the operator's safety cannot be guaranteed. Some operating conditions not permitted are the following:

- Using the unit for a purpose other than its intended use
- Using the unit when any part of it is damaged, not working properly, the electrical installation is not correct, or the electrical insulation is damaged
- Protective or safety equipment is non-functional, defective, improperly installed, or missing
- The unit or operating parameters were modified without consulting the manufacturer
- Operation in areas exposed to explosion hazards
- Operation without a cooling media not recommended by the manufacturer
- Any equipment connected to RS232 must be certified to IEC 61010-1/ IEC 60950-1/ IEC 62368-1 should be connected to the DB-9 port.
- Only Laird approved cable must be used to connect Flow meter to the unit. Refer to [Spare Parts](#) to order this cable.
- High Temperature Limit on Coolant Return - The maximum allowable coolant return (inlet) is 50°C. It is the responsibility of the customer to ensure that this limit is not exceeded. Laird Thermal Systems recommends a thermal shutoff be used in conjunction with the equipment being connected to the Recirculating Chiller. Methods include:
 - A method to turn off the heat load from injecting additional heat into the coolant. This will allow the Recirculating Chiller to reduce the temperature of the coolant further until stable.
 - A method that stops or restricts the coolant flow into the Recirculating Chiller. This will result in a Coolant High Pressure alarm, which will shut down the system for safety.
 - A method that interrupts the power to the Recirculating Chiller.

If any of these methods are activated, please reference the [Alarms](#) section.

NOTE

The manufacturer is not liable for damage occurring when using the unit in a way it was not intended. This also voids Laird Thermal Systems' warranty.

Specialized Knowledge

NOTE

Authorized persons

Servicing the unit is limited to individuals with adequate knowledge and training pertaining to the required area of service. In some circumstances licensed professionals are required to perform the required service work.

The activities listed [Table 1](#) in may only be performed by personnel with specialized knowledge.

Table 1: Activities and specialized knowledge

Activities	Qualifications
Working on mechanical and / or hydraulic installations	Industrial technician or sufficiently instructed personnel who can work on the unit under the guidance of the manufacturer’s technical support or installation instructions
Working on electrical installations and equipment	Skilled and licensed electrician
Working on refrigeration components and systems	Skilled and licensed refrigeration technician

Safety and Signaling Equipment Included in the Unit

The unit is equipped with the following safety equipment:

- The maximum pump pressure is limited by a ‘coolant supply high pressure’ alarm condition. When the coolant supply pressure exceeds a pre-set value, the entire unit is turned off by the controller. In addition to this, there is a secondary customer configurable maximum pump pressure alarm. This alarm alerts the customer once the pressure reaches a pre-set value, it doesn’t turn off the unit. This secondary pressure alarm is ‘Off’ by default.
- The maximum current drawn by the pump is limited by a pump overcurrent switch. If the pump consumes more than allowable limit continuously, the switch opens the circuit and cuts power to the pump.
- The minimum coolant level in the system is detected by a ‘low fluid level’ alarm condition triggered by an optical level switch. When the coolant level drops below the LOW” level marking on the front of the chassis, the controller shuts off the entire unit.
- Coolant leakage out of the system is detected by the ‘low coolant pressure’ alarm condition. When the coolant supply pressure sensor detects a pressure below the pre-set value, this alarm condition is triggered, and the controller shuts off the entire unit
- Refrigerant leakage from the unit is detected by a ‘low refrigerant suction pressure’ alarm in the unit. When the refrigerant suction pressure falls below the pre-set value, the controller shuts off the entire unit
- The maximum pressure in the refrigeration system is limited by a refrigerant high-pressure switch. This switch is located on the compressor discharge line and switches power from the main controller to power board. This in turn opens and closes power to the compressor. This switch opens when the pressure reaches 29.3 bar (425 psi). The switch closes again when the refrigerant pressure falls below 22.4 bar (325 psi) pressure.
- Controller has a freeze protection incorporated into the LCD. The default temperature selection that can be made is only 10C to 40C, when the coolant selected by the customer is water (default). Depending on the other coolant options selected the setpoint temperature can be selected to below 10C value. More details are given under [Choosing the Coolant](#)
- The coolant supply temperature is monitored by the controller. There are two temperature delta alarms monitoring this. The *low temperature delta alarm* alerts the customer if the coolant supply temperature is not within certain pre specified temperature delta below the temperature set point in a specified amount of time, after starting the unit or changing the set point. Similarly, the *high temperature delta alarm* alerts the customer if the coolant supply temperature is not within certain pre-specified temperature delta above the temperature set point in a specified amount of time after starting the unit or changing the set point.
- The compressor current drawn is limited by a 30A fuse on NRC1200 and NRC2400 models and a 50 A fuse on the NRC5000 model. Refer to [spare parts](#) for a replacement fuse.

- Optional alarm with flow sensor kit option: The circulated coolant flow rate is monitored by a flow sensor. If the coolant flow rate falls below a pre-specified value by the customer, then the controller shuts off the entire unit.

Guards

Direct access to hazardous parts or areas of the unit is prevented by the unit cover. The unit cover may only be removed for maintenance or repairs. It must be closed prior operating the unit. Note: warranty conditions before opening the guards.

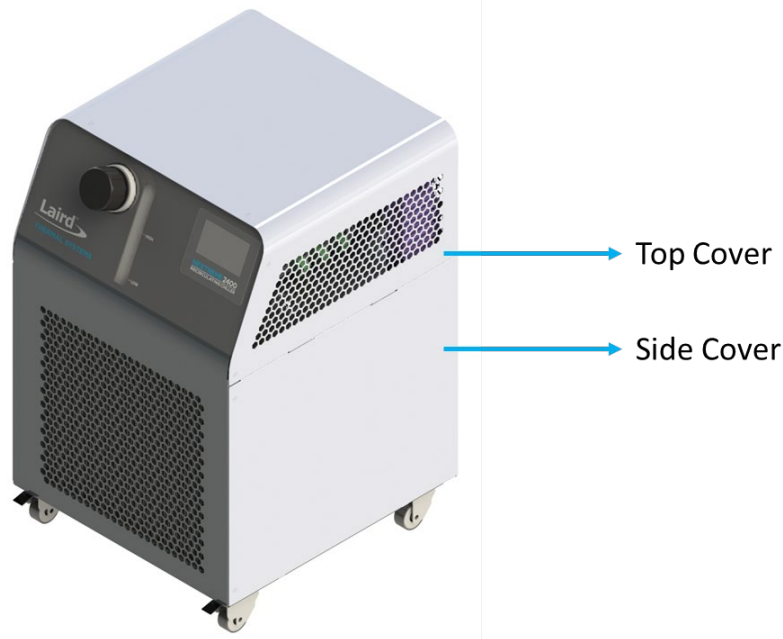

Figure 1 Guards

In Case of Accidents

Should you or another person be injured when working with the unit, do the following:

- Stay calm
- Perform first aid
- Always call the company's first aid personnel
- If necessary, call the applicable emergency number

First Aid at Accidents with R513A

The unit contains the refrigerant R513A in a closed-circuit system. If the system is damaged, the cooling fluid can spill and cause hazard including but not limited to the following occurrences:

- Fast vaporizing fluids can lead to frostbite.
- Vapor is heavier than air and can lead to asphyxiation in enclosed, poorly ventilated or low-lying areas.
- Misuse or intentional inhalation abuse may cause death without warning symptoms, due to cardiac effects and may also cause arrhythmia.

Always adhere to manufacturer safety regulations when handling spilled refrigerant.

Environmental Issues

Environmentally conscious and anticipatory behavior of staff helps avoid environmentally hazardous events. The following apply for environmentally conscious behavior:

- Environmentally hazardous substances must be stored in appropriate containers to avoid releasing them into the soil or drainage systems.

- Environmentally hazardous substances must be used or disposed of according to regional regulations.
- When dealing with working fluids, always be aware of the safety data sheet of the corresponding manufacturer.

Refrigerant R513A

The refrigerant used in the unit is classified to be slightly dangerous to groundwater and contains fluoridated greenhouse gas.

- Do not release into canalization or waters.
- Do not release into the atmosphere.
- Storage only in approved containers.
- Waste disposal only by qualified contractors.

Always adhere to manufacturer safety requirements when handling operating supplies.

Model Number Description

NRC2400-A1-20-ST1- _ _ _

Basic Model No.	Cooling Engine	Electrical Configuration	Pump Options
NRC1200 1,200 Watts NRC2400 2,400 Watts NRC5000 5,000 Watts	A1 Air Cooled / R513A	10 100-120V~, 1ph, 50/60Hz † 20 220-230V~, 1ph, 50/60Hz	ST1 Stainless, Turbine Pump

Notes:

System option codes are added to the end of the model number in alphabetical order.

† only available with NRC1200.

See **Laird Thermal Systems Online Wizard Configurator for Manufacturer's Part Number.**

www.lairdthermal.com

Specifications

TECHNICAL SPECIFICATIONS	
Model	NRC1200 (120V or 230V)
Performance	
Cooling Capacity ¹	1,600 Watts (5,460 BTU/hr)
Setpoint Range	-10°C to 40°C (14°F to 104°F)
Temperature Stability	±0.1°C (±0.2°F)
Nominal Flow Rate ¹ (50Hz / 60Hz)	15 lpm @ 1.5 bar / 15 lpm @ 2.6 bar (3.9 gpm @ 22 psi) / 3.9 gpm @ 38 psi)
Maximum available pressure	4.1 bar (60 psi)
Refrigerant	R 513A
Storage	
Temperature, w/o coolant	-25°C to 70°C (-13°F to 158°F)
Humidity	5% to 95%, non-condensing
Operation	
Coolant	Water or Water/Glycol
Temperature ²	15°C to 40°C (59°F to 104°F)
Relative Humidity	30% to 80%
Altitude	2,000 meters (6,560 feet)
Input	
Maximum rated current, Voltage and Frequency	15.8 A @ 100 V, 50 Hz and 16 A @ 100-120V, 60 Hz or 7.8 / 8.1 A @ 220-240 V 50/60 Hz
Physical	
Dimensions, W x D x H	45 X 52 x 67 cm (17.7 x 20.5 x 26.4 in)
Weight (w/o coolant)	48 kg (106 lbs)
Coolant Capacity	5 L (1.3 gal)
Couplings	1/2" NPT
Compliance	CE, UL Mark for Laboratory Equipment (ANSI / UL / CSA / IEC EN 61010–1 Edition 3)

1. Nominal capacity rating is given at a 20°C (68°F) setpoint, 20°C (68°F) ambient temperature, sea level, and 60Hz operation.
2. For ambient conditions outside this range, please contact Laird Thermal Systems.

TECHNICAL SPECIFICATIONS	
Model	NRC2400
Performance	
Cooling capacity ¹	2,800 Watts (9,554 BTU/hr)
Setpoint Range	-10°C to 40°C (14°F to 104°F)
Temperature Stability	±0.1°C (±0.2°F)
Nominal Flow Rate ¹ (50Hz / 60Hz)	15 lpm @ 1.6 bar / 15 lpm @ 2.7 bar (3.9 gpm @ 23 psi / 3.9 gpm @ 39 psi)
Maximum available pressure	4.1 bar (60 psi)
Refrigerant	R 513A
Storage	
Temperature, w/o coolant	-25°C to 70°C (-13°F to 158°F)
Humidity	5% to 95%, non-condensing
Operation	
Coolant	Water or Water/Glycol
Temperature ²	15°C to 40°C (59°F to 104°F)
Relative Humidity	30% to 80%
Altitude	2,000 meters (6,560 feet)
Input	
Maximum rated current, Voltage and Frequency	8.0 / 8.4 A @ 220-240 V 50/60 Hz
Physical	
Dimensions, W x D x H	48 X 52 x 75 cm (18.9 x 20.5 x 29.5 in)
Weight (w/o coolant)	54 kg (119 lbs)
Coolant Capacity	5 L (1.3 gal)
Couplings	1/2" NPT
Compliance	CE, UL Mark for Laboratory Equipment (ANSI / UL / CSA / IEC EN 61010-1 Edition 3)

1. Nominal capacity rating is given at a 20°C (68°F) setpoint, 20°C (68°F) ambient temperature, sea level, and 60Hz operation.
2. For ambient conditions outside this range, please contact Laird Thermal Systems.

TECHNICAL SPECIFICATIONS	
Model	NRC5000
Performance	
Cooling Capacity ¹	4,900 Watts (16,720 BTU/hr)
Setpoint Range	-10°C to 40°C (14°F to 104°F)
Temperature Stability	±0.1°C (±0.2°F)
Nominal Flow Rate ¹ (50Hz / 60Hz)	15 lpm @ 1.7 bar / 15 lpm @ 2.8 bar (3.9 gpm @ 25 psi / 3.9 gpm @ 41 psi)
Maximum available pressure	4.1 bar (60 psi)
Refrigerant	R 513A
Storage	
Temperature, w/o coolant	-25°C to 70°C (-13°F to 158°F)
Humidity	5% to 95%, non-condensing
Operation	
Coolant	Water or Water/Glycol
Temperature ²	15°C to 40°C (59°F to 104°F)
Relative Humidity	30% to 80%
Altitude	≤2,000 meters ≤(6,560 feet)
Input	
Maximum rated current, Voltage and Frequency	8.1 A @ 200-230 V 50 Hz 9.1 A @ 208-240 V 60 Hz
Physical	
Dimensions, W x D x H	63 x 59 x 91 cm (24.8 x 23.2 x 35.8 in)
Weight (w/o coolant)	100 kg (220 lbs)
Coolant Capacity	5 L (1.3 gal)
Couplings	1/2" NPT
Compliance	CE, UL Mark for Laboratory Equipment (ANSI / UL / CSA / IEC EN 61010-1 Edition 3)

1. Nominal capacity rating is given at a 20°C (68°F) setpoint, 20°C (68°F) ambient temperature, sea level, 60Hz operation, and the ST1 pump.
2. For ambient conditions outside this range, please contact Laird Thermal Systems.

Component Locations



Figure 2 Isometric Views of Unit

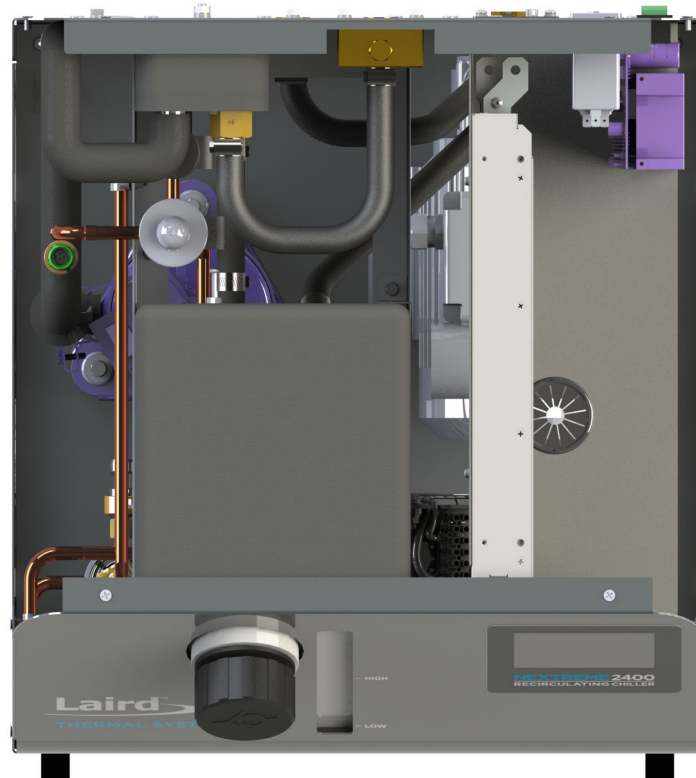

Figure 3 Top View

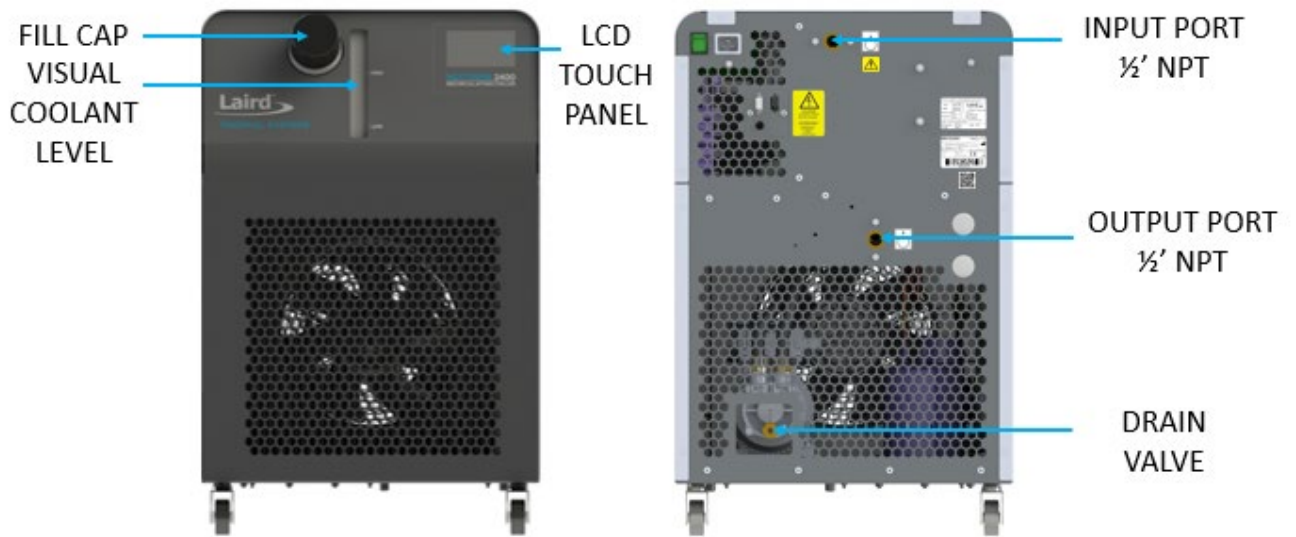

Figure 4 Front View

Figure 5 Rear View

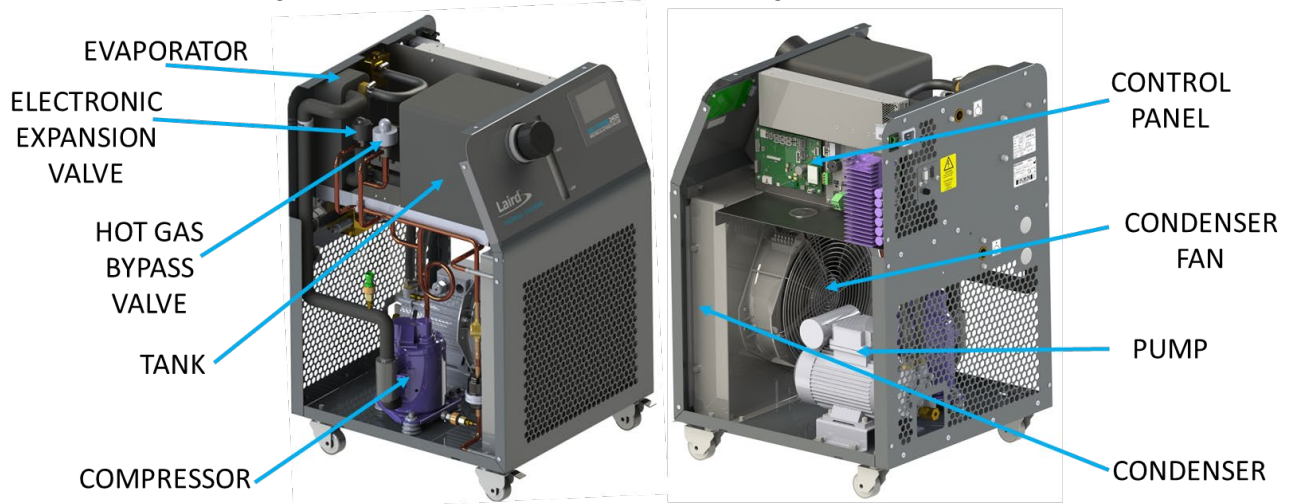
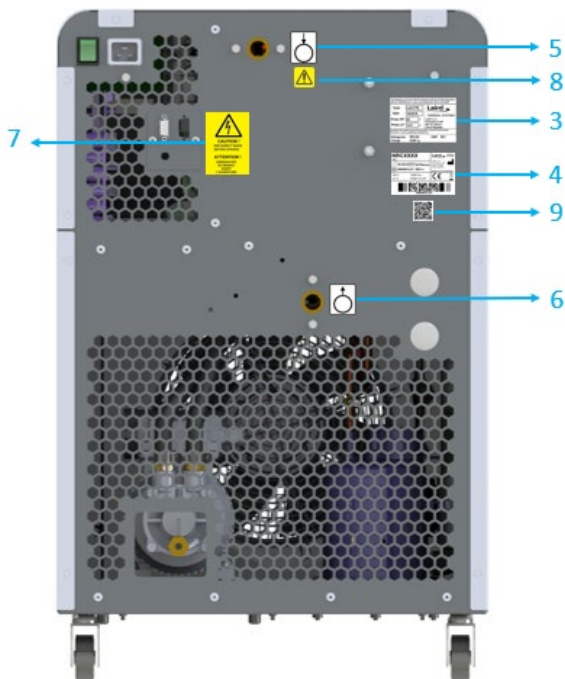
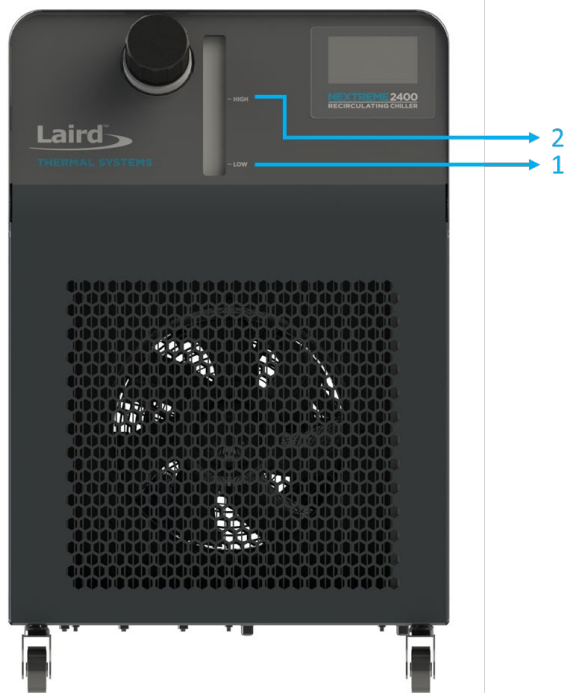

Figure 6 Side Views

Labels and Markings



- 1 – Coolant level low marking
- 2 – Coolant level high marking
- 3 – Refrigerant information label
- 4 – Laird serial number label
- 5 – Coolant return label (to the unit)
- 6 – Coolant supply label (to the unit)
- 7 – Caution hazardous voltage label: This label indicates location on the unit where power connections need to be made by the user. Caution labels on the unit such as this must always be easily readable. Illegible caution labels must be immediately replaced.
- 8 – Caution label: temperature of the coolant into the system must not exceed 50°C
- 9 – QR code for information on chiller

Optional System Features

Coolant Filter Kit

The Coolant filter is hot swappable with a bypass valve. When filter cartridge change is required, the Filter can be put in bypass mode in order to change the cartridge without affecting flow. Note: For assembling the fittings, use PTFE thread sealant tape provided with the kit to ensure a tight seal and to prevent leakage

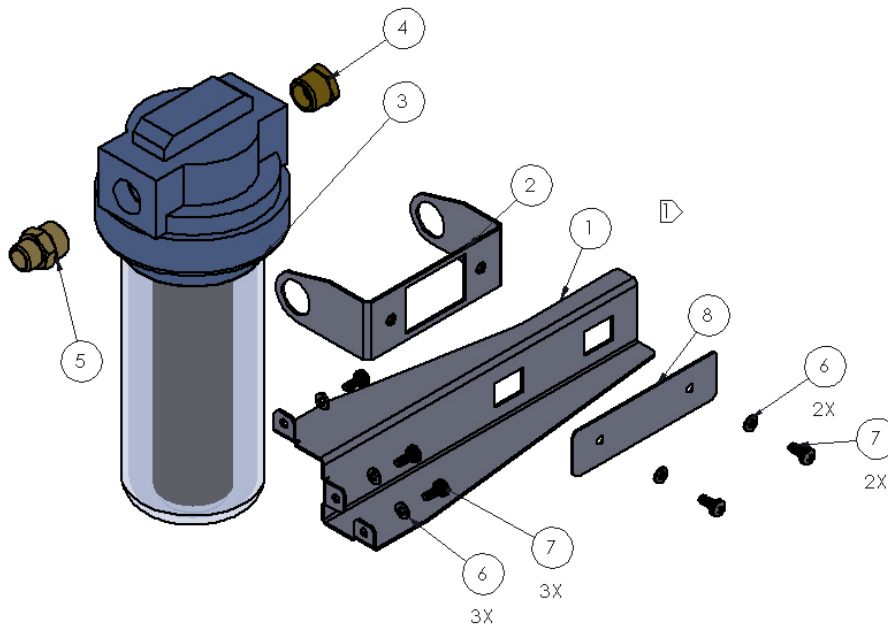
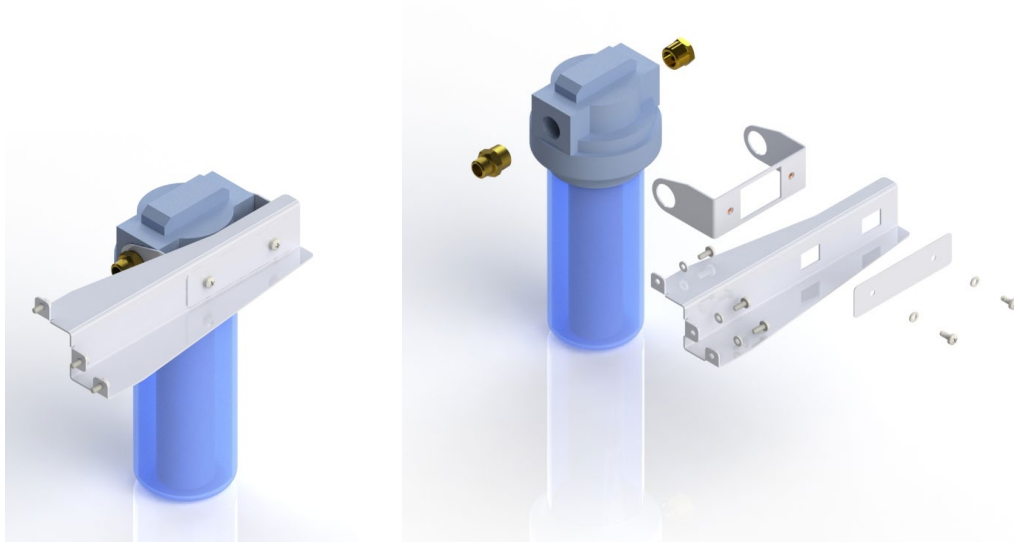

2. USE THREAD SEALANT 387005736 INCLUDED IN THE KITS FOR ALL THREADED FITTINGS
3. A WRENCH IS INCLUDED WITH THE FILTER TO LOOSEN AND TIGHTEN THE FILTER HOUSING DURING FILTER REPLACEMENT

ITEM NO.	PART NUMBER	DESCRIPTION	QTY.
1	387005711	FILTER BRACKET PAINTED NRC	1
2	387005712	FILTER BRACKET SUPPORT PAINTED NRC	1
3	387004178	FILTER HOUSING,5 GPM,INTEGRAL BYPASS,DUPONT WFPF38001C	1
4	387004190	HEX BUSHING,3/4 INCH X 1/2 INCH,BRASS	1
5	387004188	REDUCER,3/4 INCH X 1/2 INCH,BRASS	1
6	387002018	WASHER FLAT M6,A2 SS,ISO 7090	5
7	387004076	SCREW,PAN HEAD,INT LOCK,M6,16mm L,SS	5
8	387005713	FILTER BRACKET WASHER PAINTED NRC	1

Figure 9 Coolant Filter Kit Part List

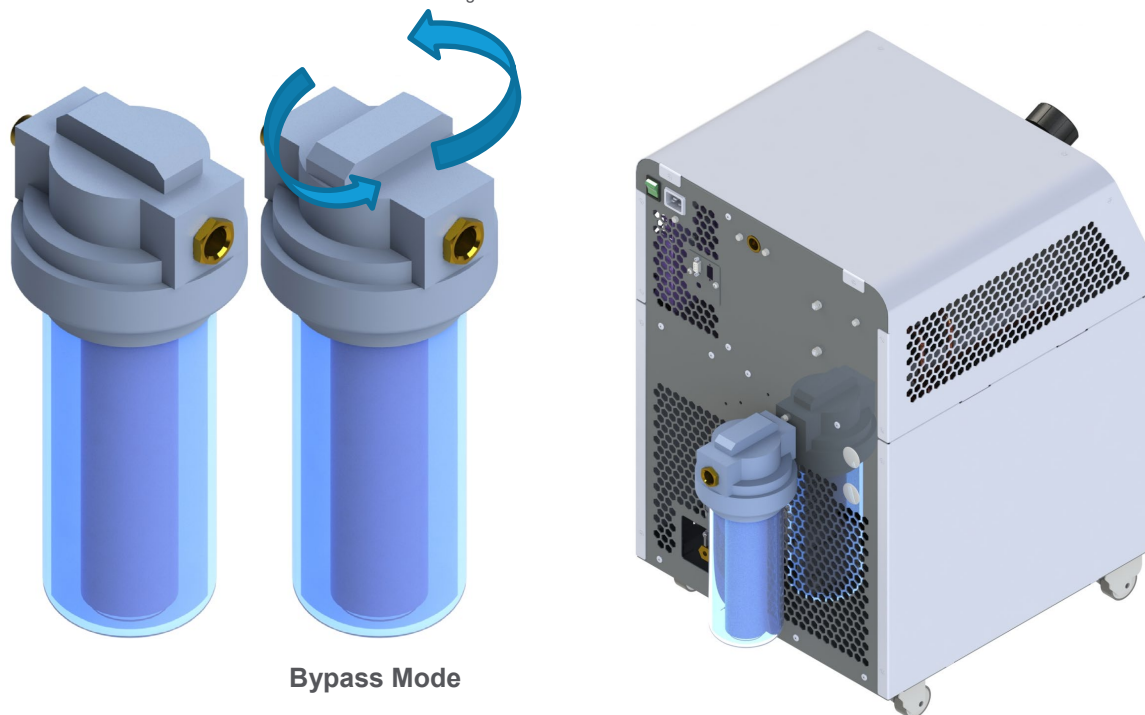

Bypass Mode

Figure 10 Bypass mode of Filter/Coolant Filter Kit assembled on Unit

Flow Control Kit

The Flow Control Kit comprises of a Flow Control Valve, Flow Sensor, and associated supporting parts. The flow rate can be adjusted according to the application and can be monitored. Refer [Inadmissible Operating Conditions](#) to avoid any safety hazards. Note: For assembling the fittings, use PTFE thread sealant tape provided with the kit to ensure a tight seal and to prevent leakage.

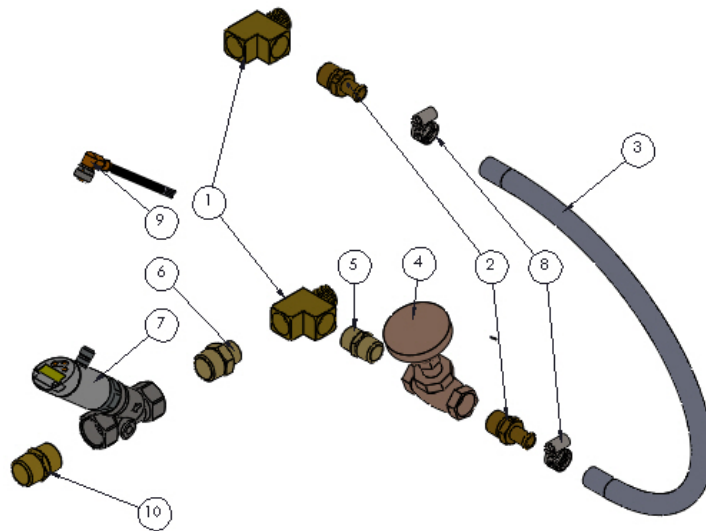

2. USE THREAD SEALANT 387005736 INCLUDED IN THE KITS FOR ALL THREADED FITTINGS

ITEM NO.	PART NUMBER	DESCRIPTION	QTY.
1	387006889	RIGHT-ANGLE TEE ADAPTER, 1/2 NPT FEMALE X MALE	2
2	387001998	FITTING 1/2" BEADED HOSE X 1/2" NPT MALE	2
3	387004192	HOSE BYPASS FLOW CONTROL KIT NRC	1
4	387004180	FLOW-ADJUSTMENT VALVE, 1/2 NPT FEMALE	1
5	387004179	STRAIGHT CONNECTOR, 3/4 INCH NPT, BRASS	1
6	387004188	REDUCER, 3/4 INCH X 1/2 INCH, BRASS	1
7	387004187	FLOW METER, 0.2 TO 10 GPM, 3/4 INCH FNPT, IFM SBN234	1
8	387002002	CLAMP HOSE 1/2 INCH SS	2
9	387004514	LAIRD REAR PANEL TO FLOW SENSOR EXTERNAL CABLE	1
10	387004191	HEX NIPPLE, 3/4 INCH NPT, BRASS	1

Figure 11 Flow Control Kit Parts List

Assembly Instructions shown below: (Follow step numbers)

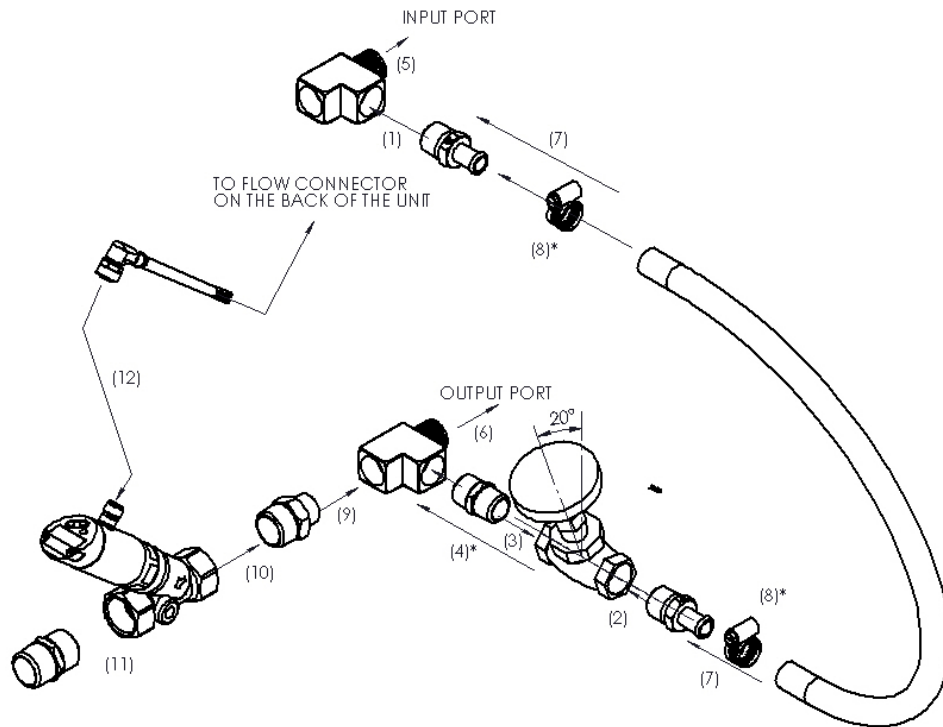

NOTES:

2. (4)* FLOW ADJUSTMENT VALVE MUST BE CONNECTED TO THE ADAPTER AT A 20° ANGLE TO ENSURE ENOUGH CLEARANCE BETWEEN THE UNIT AND THE VALVE, IN ORDER TO OPERATE THE VALVE.
3. (8)* CLAMPS SHOULD BE PLACED THROUGH THE HOSE AND THE HOSE MUST SECURED PROPERLY ON THE HOSE FITTING BEFORE TIGHTENING THE CLAMP

Figure 12 Assembly Instructions for Flow Control Kit

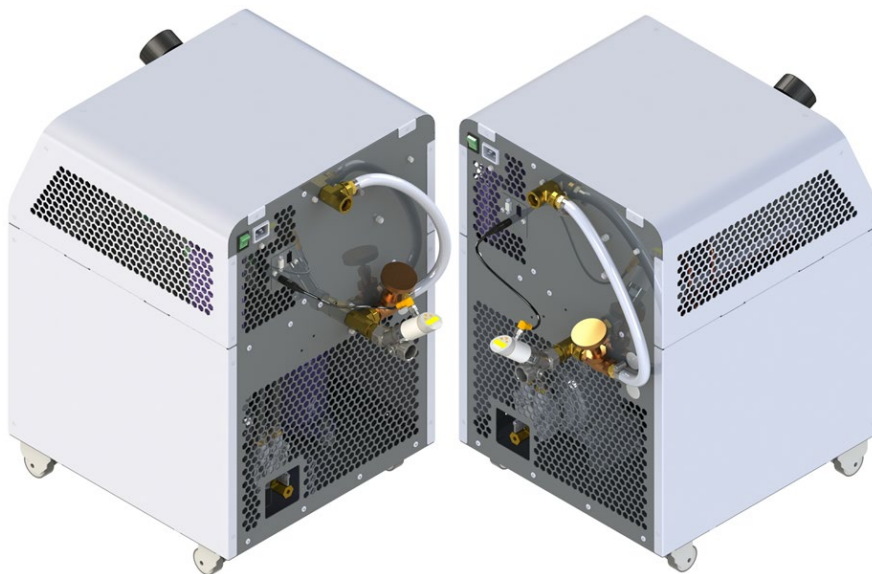
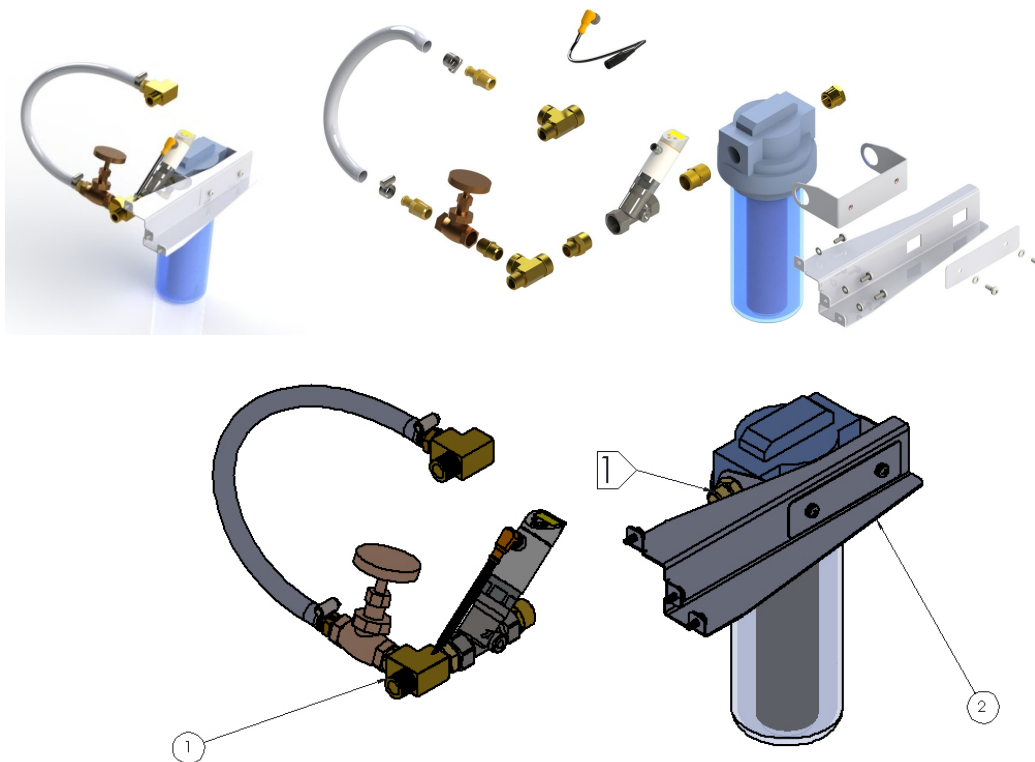

Figure 13 Flow Control Kit assembled onto Unit

Flow Control Kit with Filter

Flow control kit with Filter comprises of a Flow Control Valve, Flow Sensor, Coolant Filter and associated supporting parts. Flow rate can be adjusted depending on the application and can be monitored and Coolant will be supplied through the filter. Note: For assembling the fittings, use PTFE thread sealant tape provided with the kit to ensure a tight seal and to prevent leakage.



ITEM NO.	PART NUMBER	DESCRIPTION	QTY.
1	387004277	FLOW CONTROL KIT NRC	1
2	387004279	FILTER KIT NRC	1

2. USE THREAD SEALANT 387005736 INCLUDED IN THE KITS FOR ALL THREADED FITTINGS
3. A WRENCH IS INCLUDED WITH THE FILTER TO LOOSEN AND TIGHTEN THE FILTER HOUSING DURING FILTER REPLACEMENT

Figure 14 Flow Control Kit with Coolant Filter Parts List

Assembly Instructions shown below: (Follow step numbers)

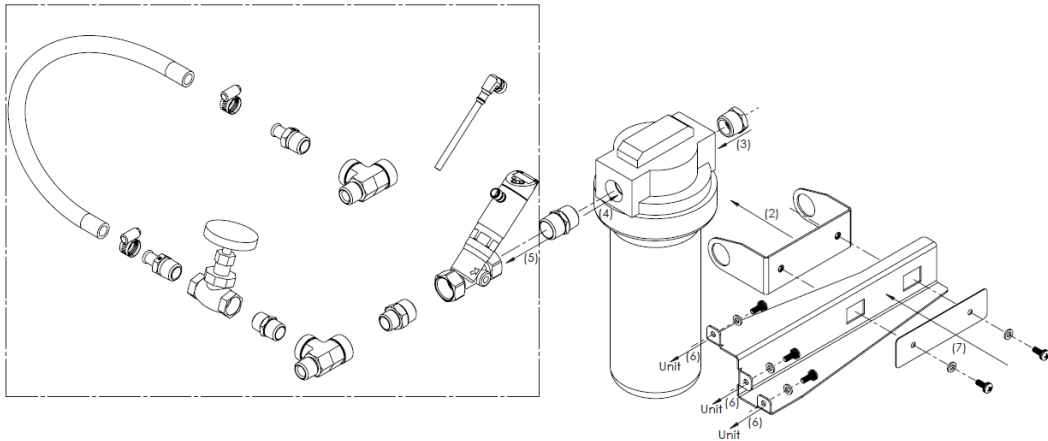

Figure 15 Assembly Instructions for Flow Control Kit with Coolant Filter

Coolant filter along with the Flow Control Kit fitted on the unit shown in picture.

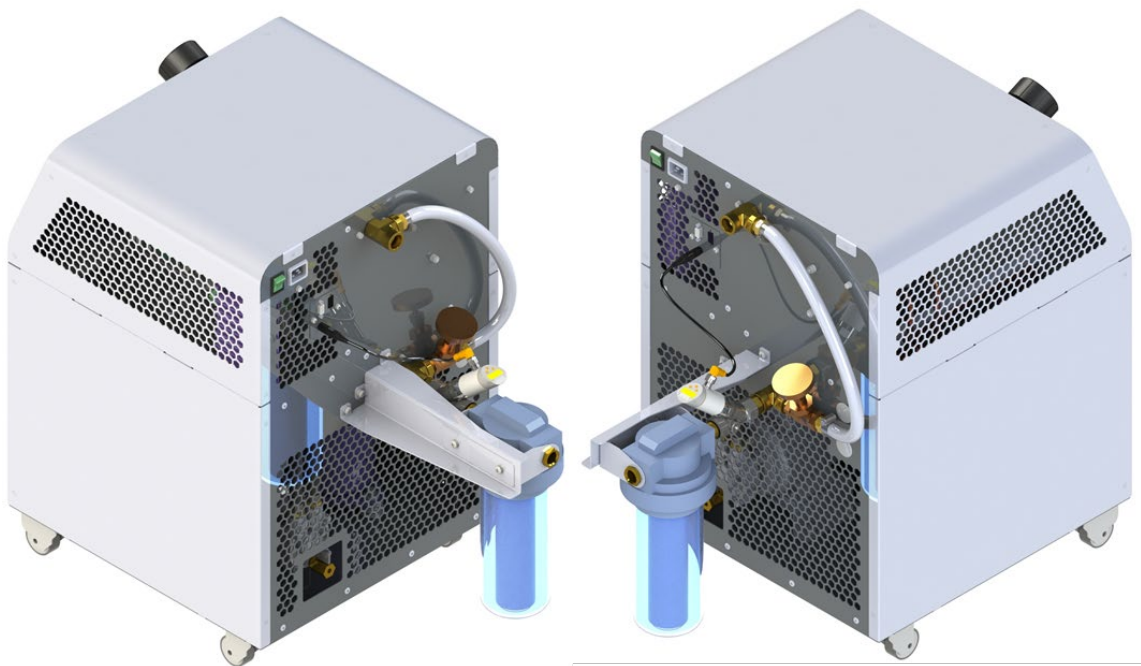

Figure 16 Flow Control Kit with Coolant Filter assembled on Unit

Transport, Packaging and Storage

Safety



WARNING

Damage due to improper transportation

Injuries to persons and significant damage to property can occur in the case of improper transportation.

- When unloading the packed unit on delivery, including in-house transport, proceed very carefully and obey the symbols and instructions on the packaging.
- Do not remove the packaging until immediately before installing the unit.

NOTE

Risk of damage through improper transportation

The mounting suspensions of different components inside the unit are not secured with transportation locks. In the case of improper transportation, these can be damaged and would need to be replaced.

- Transport the unit upright.
- Unit is not to be tilted or subjected to mechanical impact.

Checking the Delivery Condition



If any transport damage is noticed, do the following:





- Refuse the delivery or accept it with reservation.
- Note extent of damage on the transport documents or on the delivery note.
- Inform the manufacturer immediately of any damage incurred during transport.

Symbols on the Packaging

The symbols listed in [Table 2](#) attached to the packaging:

Table 2: Packaging symbols

Symbol	Meaning
	<p>Top</p> <p>The arrows mark the top of the package.</p> <p>The package must be stored and transported in such a way that the arrows always point upwards.</p>
	<p>Fragile, Handle with Care</p> <p>This symbol indicates fragile, easily breakable goods.</p> <p>Goods marked with this symbol must be handled carefully and should never be rolled or tied tightly.</p>
	<p>Keep dry</p> <p>This symbol indicates goods which are sensitive to moisture/humidity.</p> <p>Goods marked with this symbol must be protected from overly high air humidity levels.</p>

Symbol	Meaning
 DO NOT STACK ON TOP SIDE	<p>Do not stack This symbol indicates that goods are sensitive to stacking</p>
 HANDEL WITH CARE	<p>Handle with care This symbol indicates that package must be handled with care</p>
 200-250 lbs. 90-113 kg	<p>Team lift This symbol indicates that two or more persons must be used for lifting as the package is heavy</p>
	<p>Keep Upright This symbol indicates the goods are sensitive to tilt Goods marked with this symbol must not be tilted. If the symbol turns red, that means goods were tilted beyond 80° angle</p>

Packaging

NOTE

Hazard for environment due to improper disposal

Packaging materials are valuable raw materials which can be reused in many cases or reconditioned and recycled.

- Dispose of packaging materials in an environmentally friendly way.
- Follow the locally valid waste disposal regulations. If necessary, employ a special waste disposal company to dispose of packaging materials.

The unit is packed according to the anticipated transportation conditions (such as packed in sealed plastic or cardboard box on a transport pallet). The packaging function is to protect the unit against damage and corrosion until installation. The packaging material should remain on the unit until just prior to installation. Packaging includes integrated ramp.

Unpacking

Before unpacking the unit, use appropriate safety measures to make sure no person is injured in this process. Unit may be heavy.

Follow the procedure below to unpack the unit

- Cut the straps securing the cardboard box to the pallet.



b) Lift the cardboard box and remove from the top.



c) Carefully drop the fold down ramp to the floor



d) Remove the foam packing material. Slide the plastic covering on the unit to the bottom.



- e) Then carefully and steadily roll the unit down the ramp. Care should be taken to make sure the unit does not roll off the side of the ramp.



- ☐ Laird advises to keep the transport pallet (if provided) for later transportation of the unit.

Handling the Unit While in the Packaging



WARNING

Danger due to lifting and carrying heavy loads

Manual handling of the loads (lifting, pushing, and carrying) must be avoided.

- Unit weight – Refer to [Specifications](#).
- Use only suitable means of transport (such as industrial truck or lift truck).



WARNING

Danger of injury due to tipping or falling loads

Bruises. Bone fracture.

When handling with industrial truck, observe the following basic rules:

- Wear personal protective gear (such as protective footwear and protective gloves).
 - Do not walk or stand under a suspended load.
 - Use only suitable means of transport (such as an industrial or lift truck).
 - Use only industrial trucks with appropriate capacity for loading. Unit weight – Refer to [Specifications](#).
 - Secure the unit so that it cannot tip or fall.
-

Transportation on casters

The unit is equipped with lockable casters on the front end of the unit. The casters on the back end of the unit are non-lockable. To transport the unit over short distances, the unit can be moved on these casters. Extra care should be taken when transporting the unit over gaps in the floor, such as when entering / exiting an elevator.

Damage to property due to tipping of the unit.

When rollers are blocked by obstacles, there is a risk that the unit may tip.

- Move the unit slowly and carefully over flat surfaces.
- Keep possible obstacles out of the work area.

Damage to property due to unintended rolling of the unit.

- Place the unit on a level surface.
- Lock the rollers' brakes.

Storing the Unit

These storage conditions apply to the following:

- New units
- Units that were already in operation but will be temporarily out of operation. Refer to [Temporary Placing Out of Operation](#).

Store the units as follows:

- Completely drained of coolant to prevent possible damage due to freezing.
- Dry, dust-free environment, protected against direct sunlight
- According to required storage temperature and relative humidity. Refer to [Specifications](#).
- Protection caps should be installed for the coolant inlet and outlet connections.
- For storage that exceeds three months, it is recommended that the unit is placed inside its original packaging.

Preparing the Unit for Further Transport

For detailed information and specific instructions on how to prepare the unit, refer to [Safety Precautions](#).

NOTE

Risk of damage due to improper transportation

A coolant that has not been drained or packaging with inappropriate dimensions may cause damage during transport.

- Drain the coolant before transporting the unit. Refer to [Draining Procedure](#).
 - Use proper packaging.
-

Transporting the Unit (after use)

Requirements

- Unit is switched off and disconnected from the electrical power source
- Unit and coolant cooled to the ambient temperature
- Coolant is drained. Refer to [Draining the Coolant](#).
- Coolant hoses disconnected from the unit. Refer to [Disconnecting the Coolant Hoses](#).

Procedure

1. Pack the unit according to the transport conditions that can be expected.
 Laird advises to use original packaging, if available, or an equivalent packaging.
2. Mark the packaging with the appropriate symbols. Refer to [Symbols on the Packaging](#).
The unit can now be transported.

Installation Requirements

1. Minimum Clearance from obstructions is required as shown to ensure that air intake and air discharge is not blocked as this could affect cooling capacity.

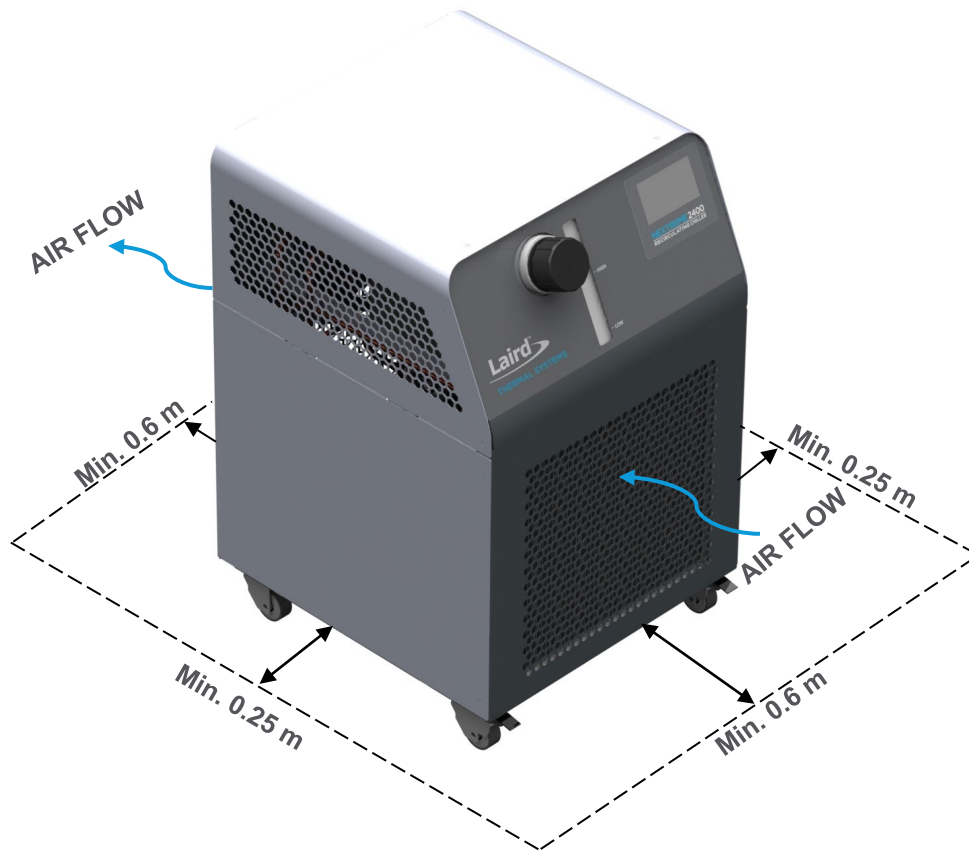

Figure 17 Minimum Clearance required for Unit Installation

2. The location must be level
3. When choosing the installation location, the following must be kept in mind:
 - a. The flow of the cooling air must not be restricted.
 - b. Coolant inlet and coolant outlet connections must be easily accessible.
 - c. Power Cord must be easily accessible.
 - d. All hoses must be installed without sharp bends.

Installation Procedure

Connect Hoses

NOTE

Risk of damage by using improper or faulty coolant hoses

This may lead to damage to persons, damage to property, or corrosion damage.

- When choosing coolant hoses pay attention to burst pressure and compatibility with coolant.
- Only use coolant hoses without any signs of damage.
- If water is being used as coolant, ensure that non-transparent hoses are used to prevent algae growth in the water. Otherwise, appropriate additives must be used.

NOTE

When connecting the coolant hoses pay attention to flow direction. Follow the documentation released by the manufacturer of the unit to be cooled.

Transparent coolant hoses increase algae growth and bio-fouling of the components in the unit and this reduces the performance of the unit. Thus, only use non-transparent coolant hoses.

The coolant hoses are connected to the unit by means of couplings. Coolant inlet and coolant outlet are labeled with respective symbols.

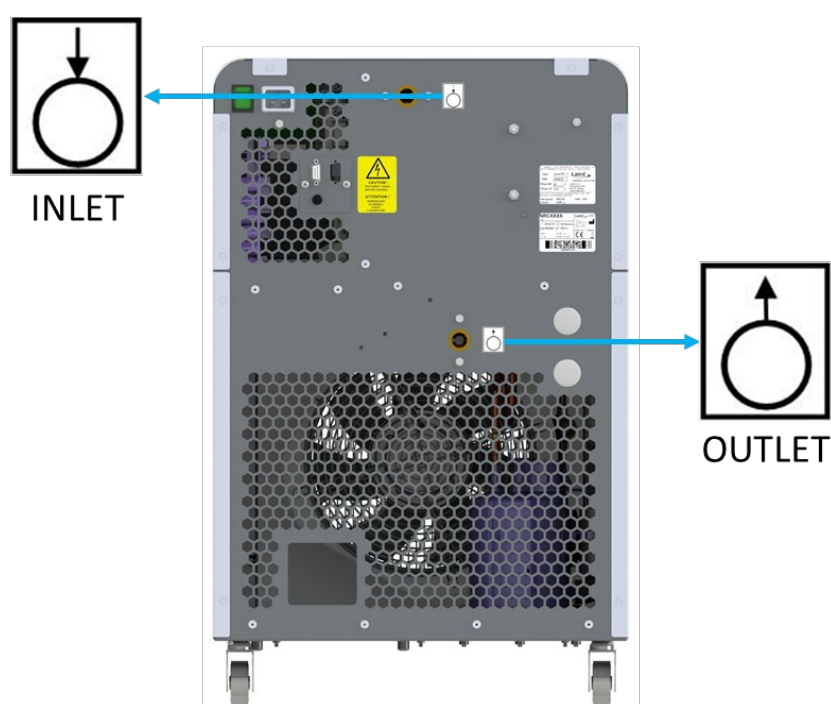

Figure 18 Connecting Hoses

Requirements

- Unit prepared for maintenance. Refer to [Preparing the Unit for Maintenance](#)
- Hoses

Procedure

1. Remove the protection caps from the coolant inlet and coolant outlet connections of the unit.
2. Connect an appropriate coolant hose to the coolant inlet and coolant outlet respectively.

3. Connect the coolant hoses to the corresponding connections of the unit to be cooled. The coolant hoses are now connected to the unit.

Disconnect Hoses

The coolant hoses are connected to the unit at the coolant inlet and coolant outlet connections, labeled with respective symbols.

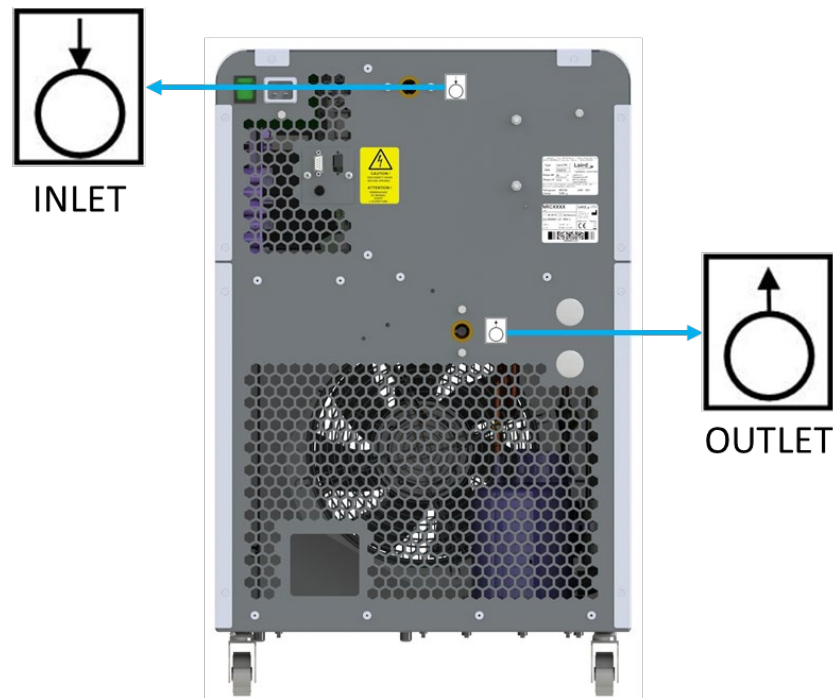

Figure 19 Disconnecting Hoses

Requirements

- Unit prepared for maintenance. Refer to [Preparing the Unit for Maintenance](#).
- Coolant cooled to the ambient temperature.

Required Tools and Materials

- Absorbent cloth
- Bonding agent
- Protection caps

Procedure

1. If the coolant inlet and outlet fittings have quick disconnects installed by the customer, disconnect the hoses from coolant inlet and outlet fittings on the back of the unit.
2. If the coolant inlet and outlet fittings do not have quick disconnects or valves, the system must be drained before disconnecting the hoses from fittings on the back of the unit.
3. Secure the coolant inlet and coolant outlet connections with protection caps against soiling.

The coolant hoses are now disconnected from the unit.

Connecting Power

Power cord is not supplied with the unit and must be ordered separately. These power cords have been tested and validated on Nextreme devices:

MFG Part Number	Plug Type	Standard	Style	Cable Length	Rating	Color	Connector
387005324	Universal	None	Flying Leads	2.0 m	250VAC, 16A* / 20A**	Black	C19
387005325	United States	NEMA 5-20P	straight	3.0 m	125V, 20A	Black	C19

* IEC ** UL

Requirements:

- The unit construction provides protection against the risk of electrical shock by grounding appropriate metal parts. The protection will not function unless the power cord is connected to a properly grounded outlet. It is the user's responsibility to assure a proper ground connection is provided.
- Power Cord with C19 connector (not supplied by Laird Thermal Systems)
- Use cable rated for 20A 250V with IEC320-C19 receptacle. The customer side of the cable must follow required standard for the country of installation

Procedure

1. Cable with a 'C19' Connector should be connected to the IEC power connection on unit as shown below.
2. Turn the Power Switch ON.
3. When the Power Switch is ON, the Power Switch should light up as well as the LCD Panel.

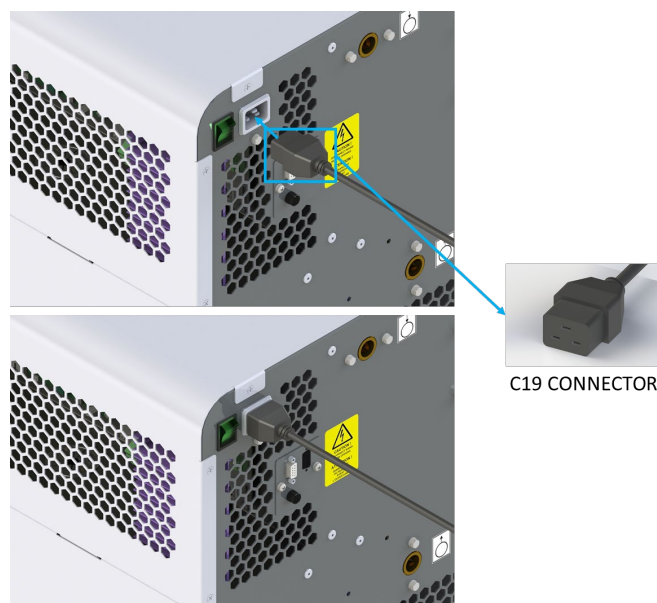

Figure 20 Connecting Power

Adding Coolant and Priming Unit

The unit is not intended for use with corrosive fluids. Automotive Antifreeze should never be used as a freezing point depression or corrosion protection fluid. Automotive antifreeze contains additives that can damage system components and will void the warranty.

Approved fluids and their normal operating temperature ranges are:

- Filtered/Single Distilled water, +10°C to +40°C
- Up to 50% Inhibited Ethylene Glycol (EG) /Water, -10°C to +40°C
- Up to 50% Inhibited Propylene Glycol (PG) /Water, -10°C to +40°C

It is important to maintain the proper mixture of EG or PG and water over time. Instruments are available on the market to measure glycol content and should be used periodically and when refilling the system to check the coolant mixture ratio.

Inhibited EG or PG should be used when the coolant is being exposed to aluminum components in order to prevent galvanic corrosion.

Suggested Contaminant Limits:

	PPM
Organics	
Algae, Bacteria, etc.	0
Inorganic Chemicals	
Calcium	<10
Chloride	<25
Copper	<1.0
Iron	<0.2
Lead	0
Magnesium	<5
Manganese	<0.05
Nitrates \ Nitrites	<10
Potassium	<2
Silicate	<5
Sodium	<4
Sulfate	<25
Hardness	<1
Total Dissolved Solids	<25
Other Parameters	
pH	6.8. 7.5
Resistivity	<0.1 MΩ-cm

Requirements

- Unit prepared for maintenance. Refer to [Preparing the Unit for Maintenance](#).
- Power connected to unit.
- Coolant hoses connected to the unit (Make sure the hoses are corrected to the correct ports).

Required Tools and Materials

- Filling funnel
- Measuring cup
- Absorbent cloth

Procedure

1. Remove the Fill Cap.
2. For information regarding coolant to be used and quantity, refer to [Specifications](#). Use a filling funnel to avoid moistening any current-carrying components with coolant.
Note: If refilling coolant, go to the last step.
3. Add coolant up to required level. Ideal coolant level is just below the 'HIGH' marking on the front view port of the tank.
4. Press the 'PUMP' button on the LCD panel to fill the coolant lines to the application.

5. When the tank level starts reducing, continue adding coolant through the fill port, until the ideal coolant level is reached with the pump continuously running.
 6. Note: Do not let the pump run dry as it can be damaged.
 7. Mount the coolant cap again.
- The coolant is now added.*

Chiller Operation

The chiller unit consists of the following subunits:

1. Refrigeration Circuit

The refrigeration circuit consists of an evaporator, compressor, condenser, expansion valve and refrigerant. The coolant returning from the customer's application exchanges with the refrigerant in the evaporator. The evaporated refrigerant is compressed by the compressor and sent to the condenser. In the condenser, heat is rejected from the refrigerant to the ambient air with the help of the condenser fan. Here refrigerant is condensed and enters the electronic expansion valve. The expansion valve cools the liquid refrigerant which then goes to the evaporator to exchange heat again with the coolant and this cycle continues. The system also consists of a 'Hot gas bypass valve' in the heating loop, where the condenser coil and expansion valve are bypassed partially or completely. The refrigerant flows through this loop for cases where the customer load is too low or where raising the temperature of the coolant is necessary to maintain stable application temperature.

2. Coolant Circuit

This circuit consists of the evaporator, coolant tank, pump and coolant. Temperature of the coolant is regulated in the evaporator which then enters the coolant tank. This coolant is circulated by the pump to maintain the customer application temperature. Coolant from the customer application is circulated back to the evaporator and this cycle continues.

3. Control Panel

The control panel is responsible for the interaction of the different components with each other and to integrate the sensors in order to achieve the required temperature setpoint. This is also used for monitoring the state of the system.

Additional information on the system can be found in the [Plumbing & Refrigeration Diagram](#) and [Wiring Diagrams](#).

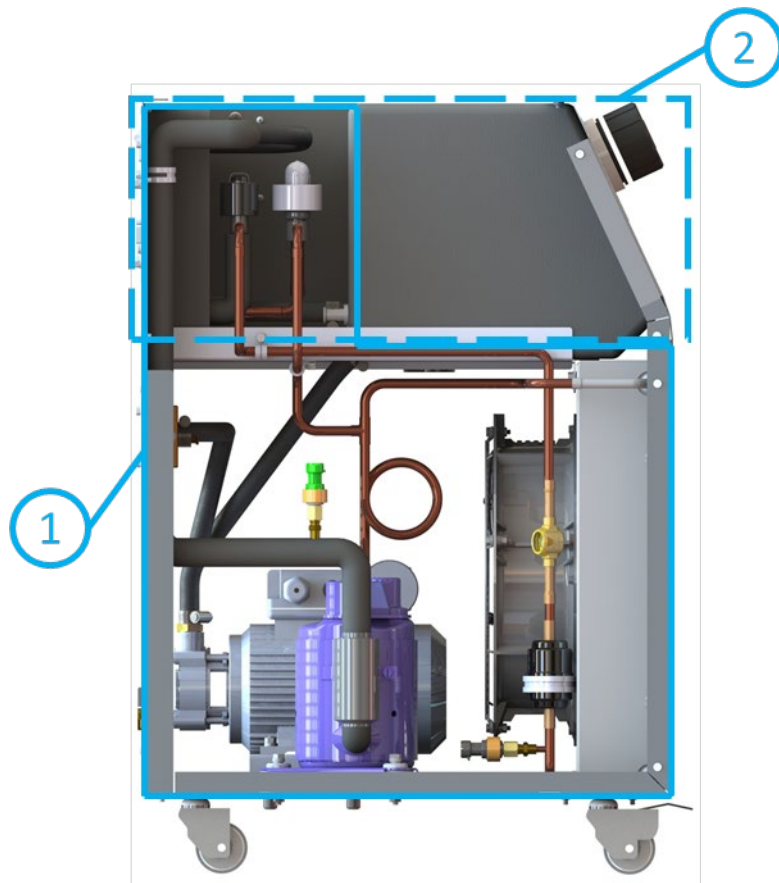

Figure 21 Refrigerant Circuit and Coolant Circuit

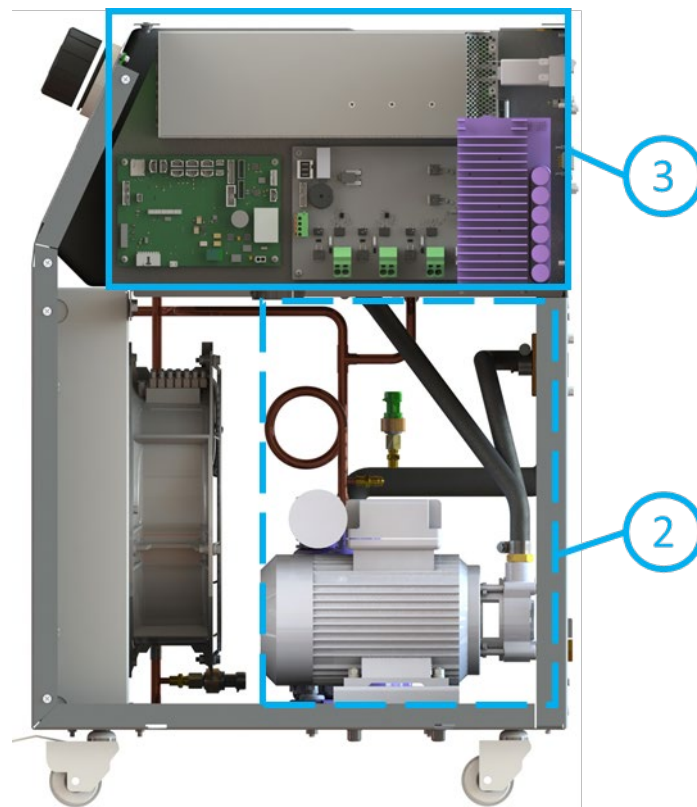

Figure 22 Coolant Circuit and Control Panel

Plumbing & Refrigeration Diagram

NEXTREME RECIRCULATING CHILLER PIPING SCHEMATIC

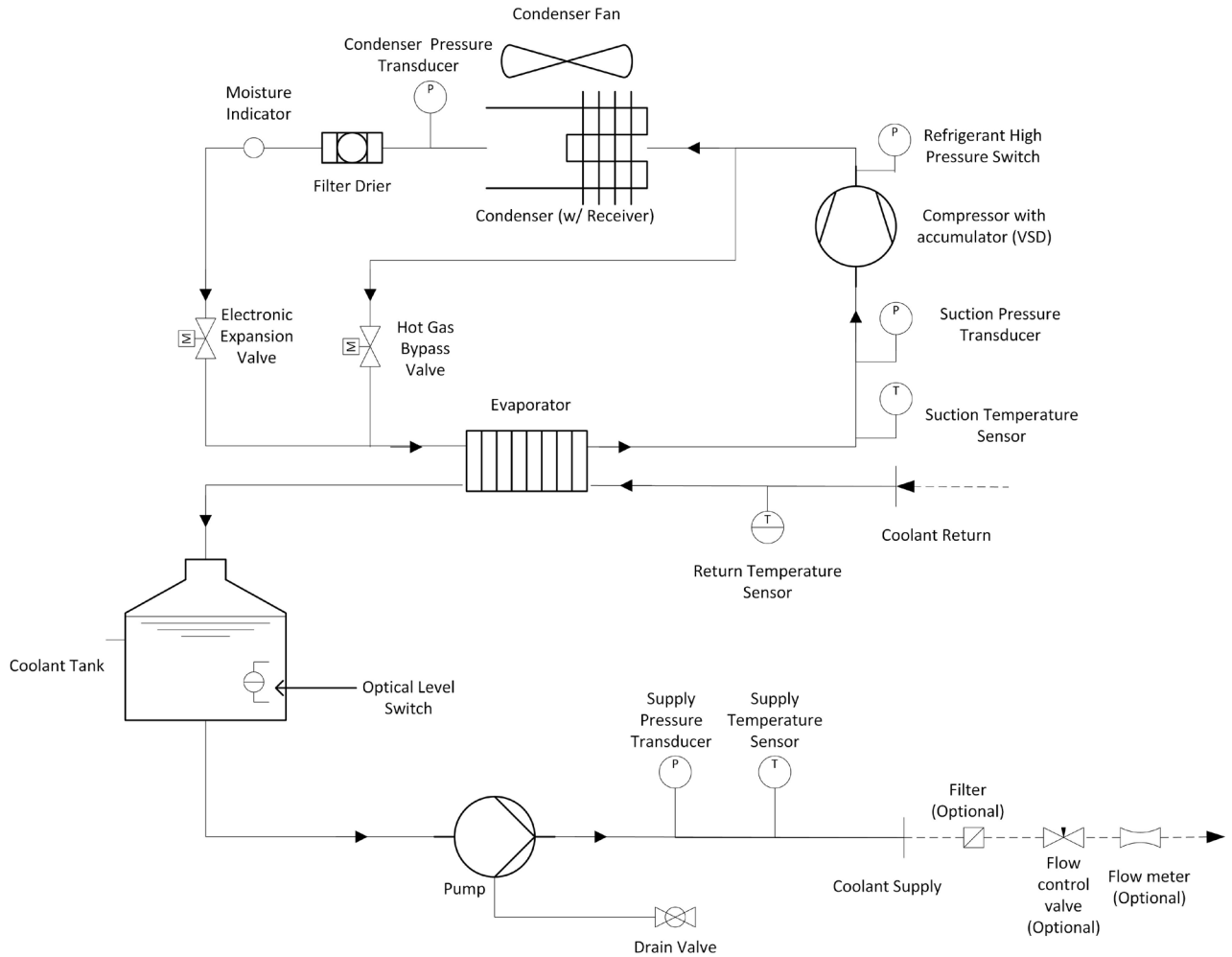

Figure 23 Plumbing and Refrigeration Diagram

Performance Graphs

Thermal Performance

NRC1200

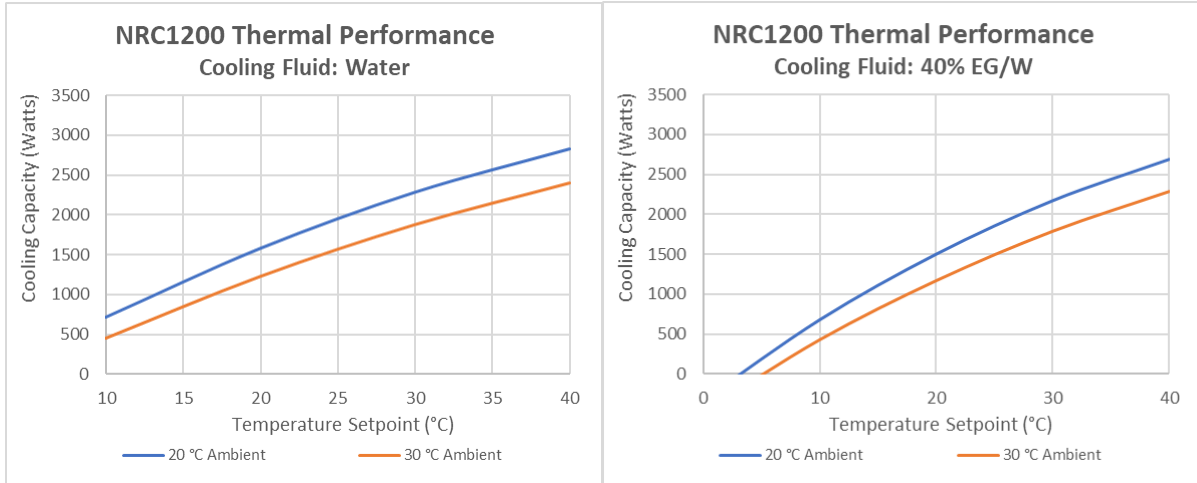

Figure 24 Thermal Performance of NRC1200 with Cooling Fluids: Water & 40% EG/W

NRC2400

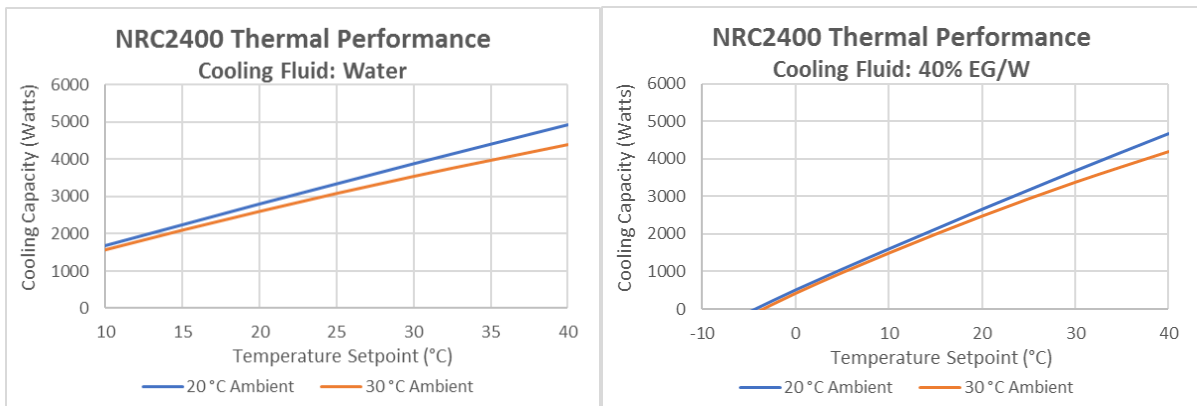

Figure 25 Thermal Performance of NRC2400 with Cooling Fluids: Water & 40% EG/W

NRC5000

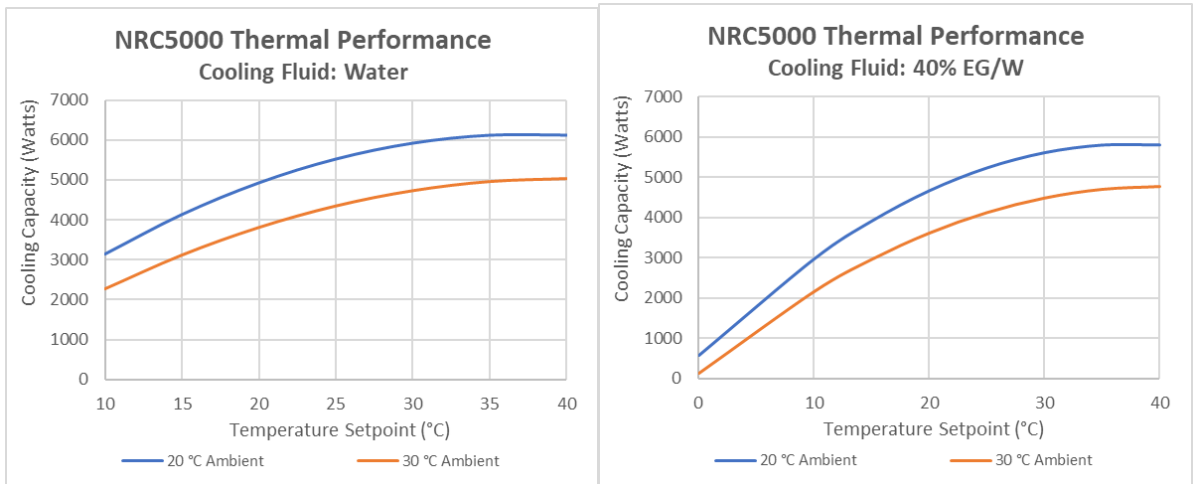

Figure 26 Thermal Performance of NRC5000 with Cooling Fluids: Water & 40% EG/W

Pump Performance

NRC1200

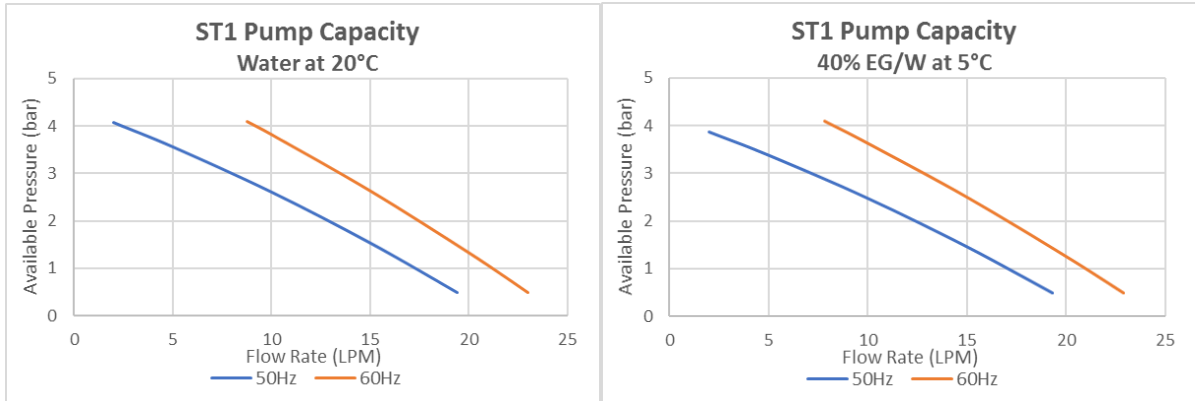

Figure 27 Pump Performance of NRC1200 with Cooling Fluids: Water & 40% EG/W

NRC2400

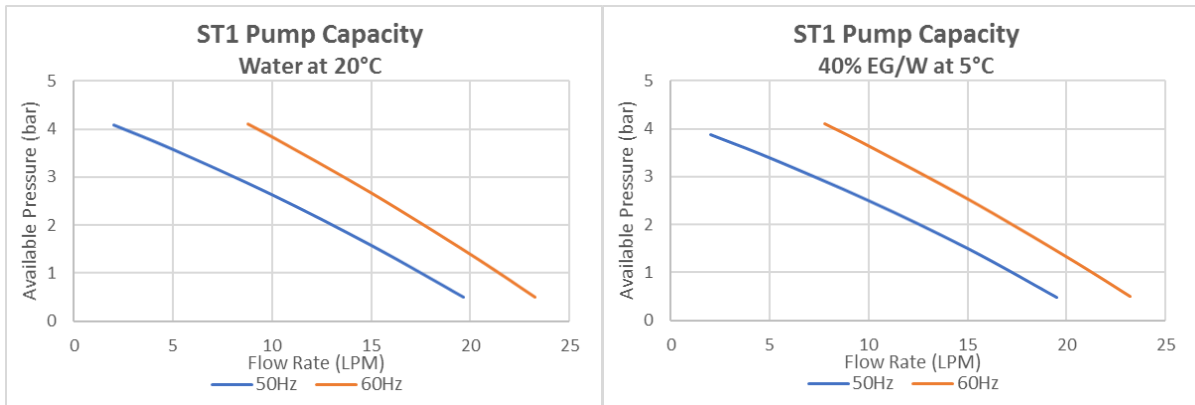

Figure 28 Pump Performance of NRC2400 with Cooling Fluids: Water & 40% EG/W

NRC5000

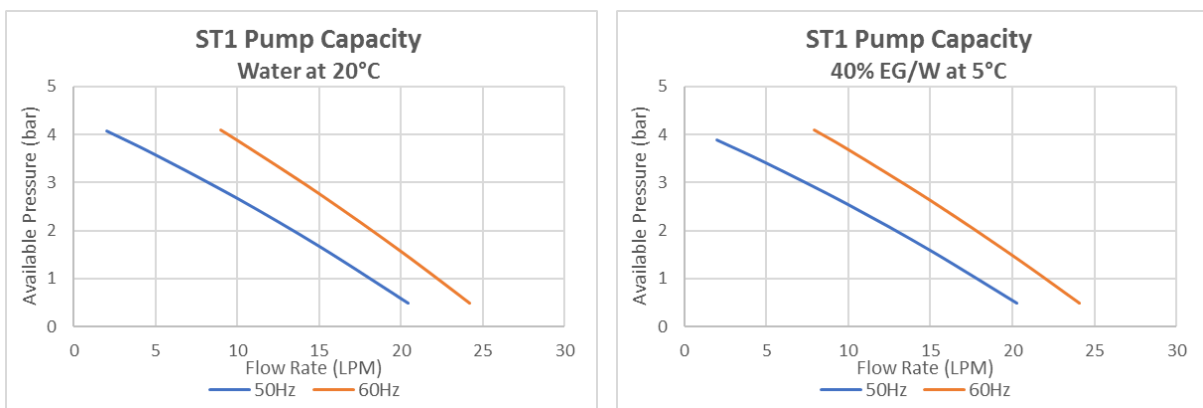

Figure 29 Pump Performance of NRC5000 with Cooling Fluids: Water & 40% EG/W

Chiller Dimensions

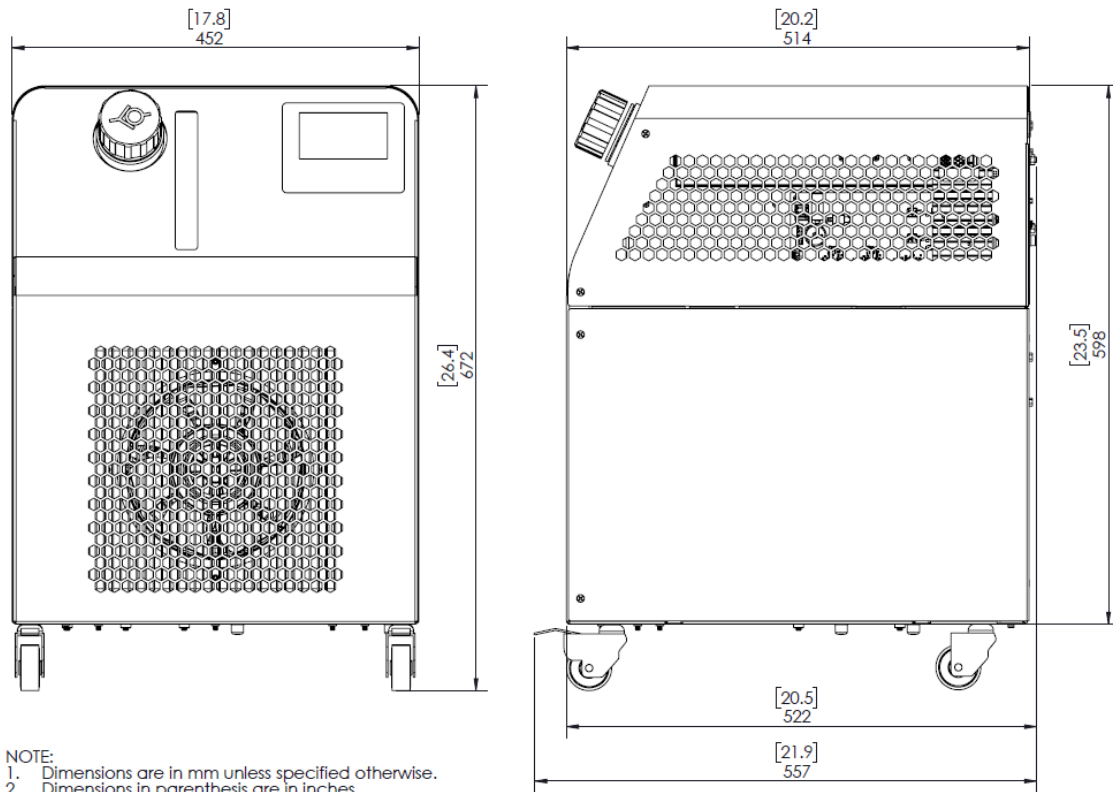

Figure 30 NRC1200 Chiller Overall Dimensions

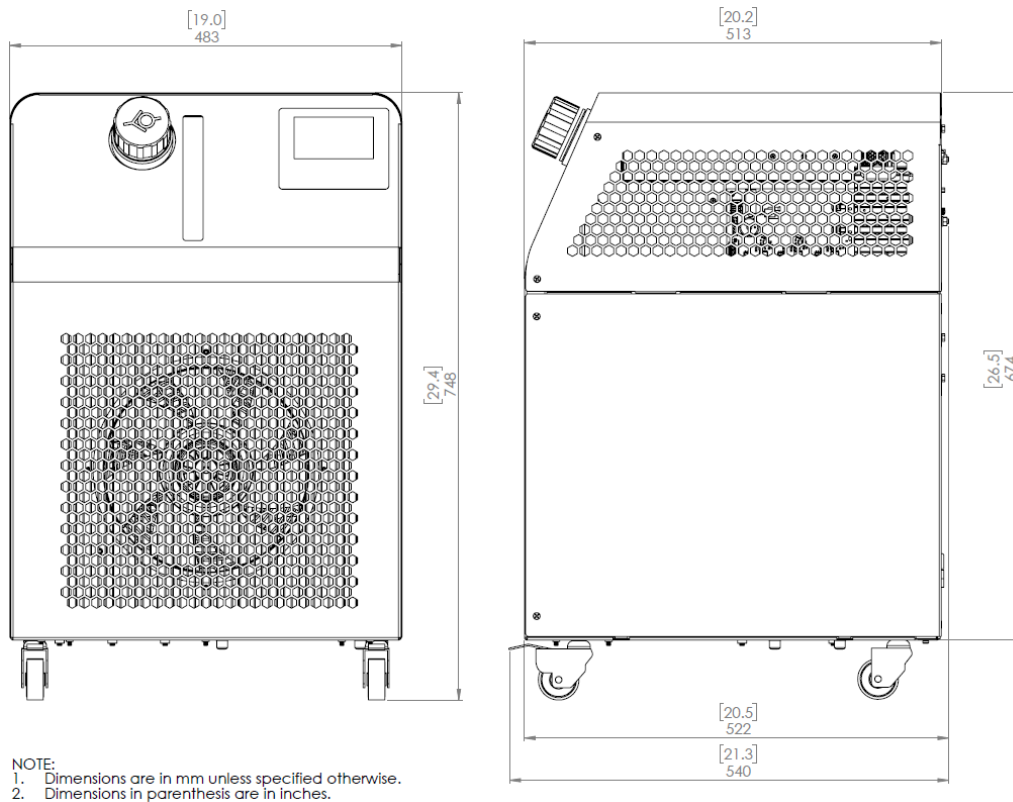

Figure 31 NRC2400 Chiller Overall Dimensions

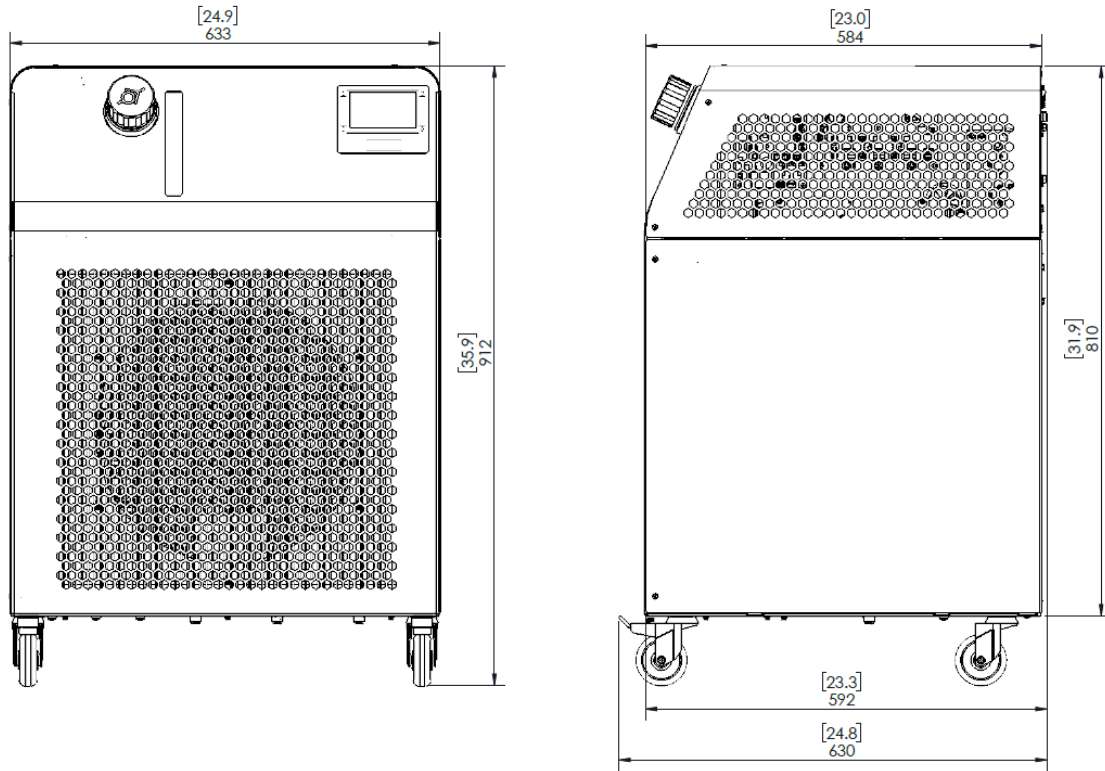

Figure 32 NRC 5000 Chiller Overall Dimensions

NOTE:

1. Dimensions are in mm
2. Dimensions in parathesis are in inches.

Controller Display Panel Functions

Startup Screen

When the unit is first powered on, the touch panel shows this screen for 10 seconds.



Figure 33 Start-up Screen

Main Screen

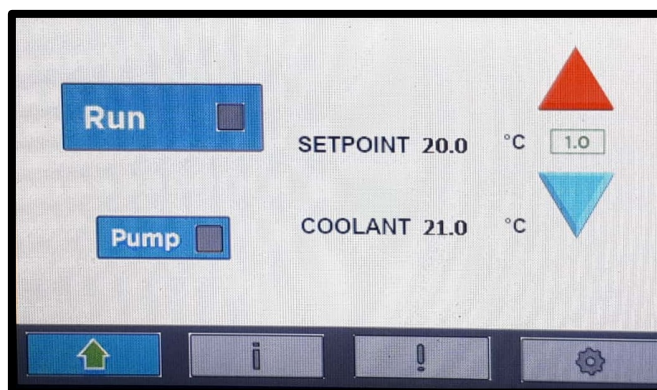

Figure 34 Main Menu

Buttons	Description
	Main Menu is selected
	Information Menu is selected
	Alarm menu is selected
	Settings menu is selected
Pump	Pump is OFF
Pump	Pump is ON
Run	Chiller is OFF
Run	Chiller is running
Pump	Pump Button is disabled since Chiller is running
	Setpoint increments/decrements in 0.1

1.0	Setpoint increments/decrements in 1.0
▲	Increase setpoint by selected increment level
▼	Decrease setpoint by selected decrement level
←	Stores set point in flash memory

Running the Pump

The pump can be switched on by pressing the PUMP button on the screen. The box will turn from grey to green which indicates that the pump is on. By clicking the PUMP button again, the pump will switch off turning the box back to grey.

Note: Pump ON/OFF function is disabled during running of machine.

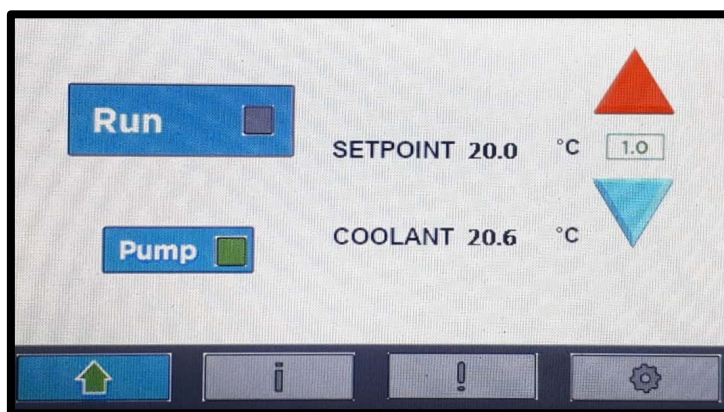

Figure 35 Running Pump

Choosing the Coolant Setpoint

The Coolant setpoint can be set by choosing values using the arrows and changing the increments accordingly. By clicking on the increments, the increment can be changed from 0.1 to 1.0 and vice versa.

Running the system

The system can be run by pressing the RUN button on screen. The box will turn from grey to green which indicates that the machine is running. In order to switch OFF the machine, click the button again.

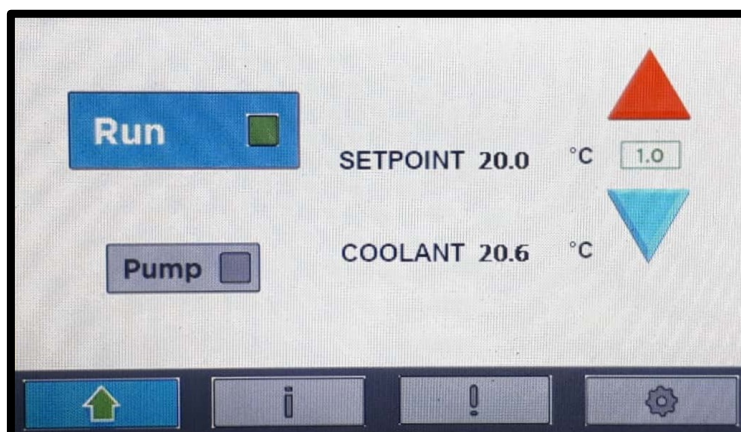

Figure 36 Running the Machine

Sleep Screen

The touch panel goes to sleep when the screen has been inactive for 3 minutes and shows coolant supply temperature. The system does not go to sleep screen when the information screen is being displayed or when the unit is not running.



Figure 37 Sleep Screen

Information Screen

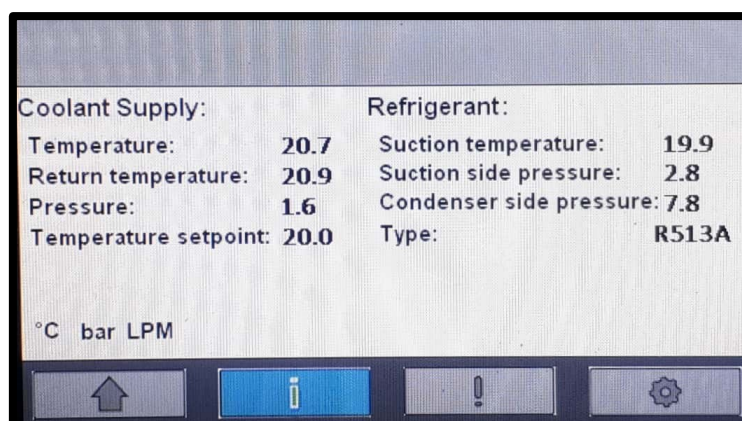

Figure 38 Information Screen

In order to see information related to Coolant Supply and Refrigerant, click on the Information Menu. According to the units selected in the settings menu, the Temperature unit and Pressure unit will be shown at the bottom.

The following information is displayed:

	Information	Description
Coolant Supply	Temperature	This is the Supply Temperature from the chiller to the application
	Return Temperature	This is the Return Temperature from the application to the chiller
	Pressure	This is the Supply Pressure to your application from the chiller
	Temperature setpoint	This is the Temperature Setpoint set by User in the Main Menu
Refrigerant	Suction Temperature	This is the temperature of the refrigerant
	Suction side pressure	This is the pressure of the refrigerant before entering the compressor
	Condenser side pressure	This is the pressure of the refrigerant after passing through the condenser
	Type	This is the type of refrigerant

Alarms Display Screen

If the system is not in an alarm condition, then the alarms tab doesn't show any alarm.

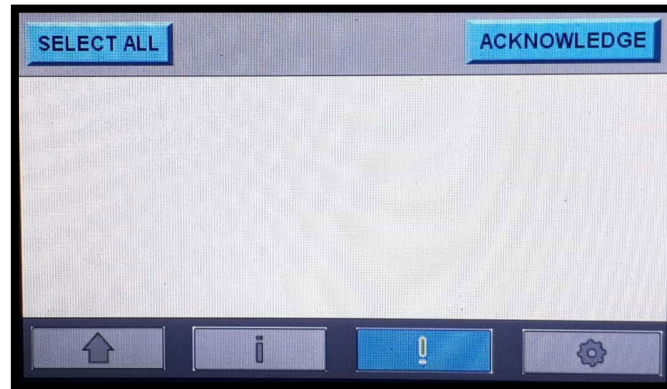

Figure 39 Alarm screen with no active alarms

If the system experiences an alarm condition, the alarm button changes on the home screen to indicate this.



Figure 40 Home screen with an active alarm

Acknowledging Alarms

Alarms can be acknowledged individually by selecting them and then pressing the ACKNOWLEDGE button. When there are multiple alarms, they can be acknowledged together by pressing the SELECT ALL button and then the ACKNOWLEDGE button.

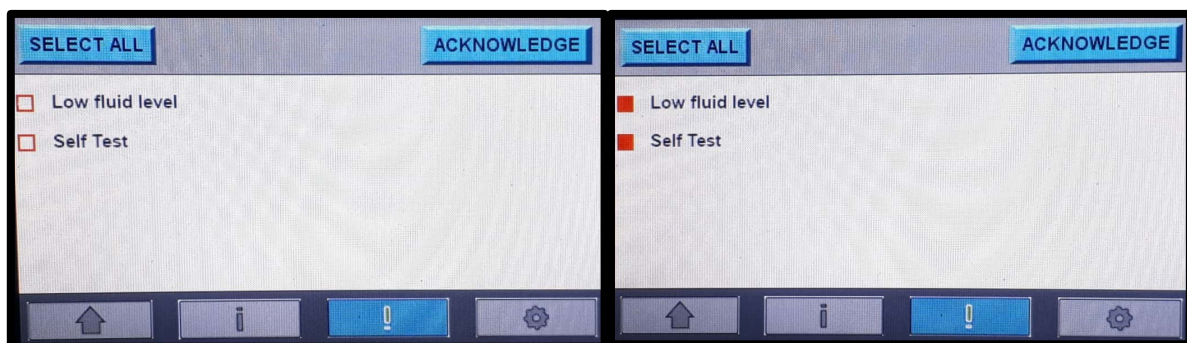







Figure 41 Acknowledging Alarms

Buttons	Description
	Alarm has been set
	Amber alarm
	Amber alarm Selected
	Red Alarm
	Red Alarm Selected

Red alarms are used to indicate an abnormal system condition and are usually associated with the shutdown of a component or the whole system. There is an audible alarm for this condition and requires an action from the customer for the system to restart.

Amber alarms are warnings to indicate an abnormal system condition, but the system or components are not shut down. There is no audible alarm for this condition.

For specific alarm conditions and troubleshooting information, refer to section [Alarms](#)

Settings Screen

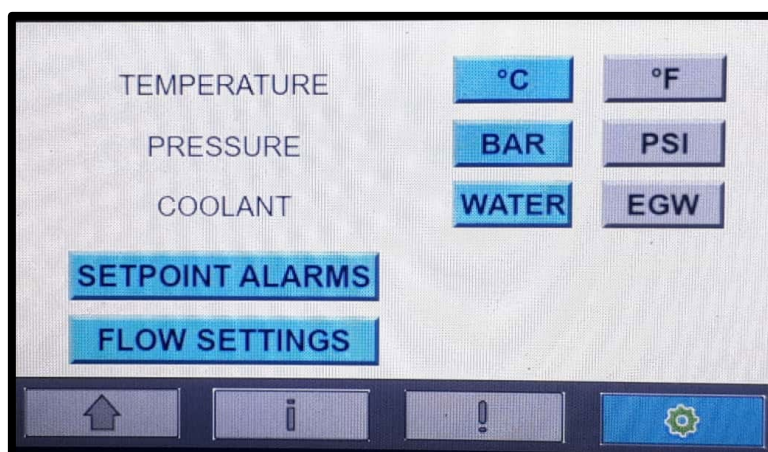

Figure 42 Setting Menu

Setting Units

The units of measure for temperature and pressure can be selected in the Settings Menu. The options available for temperature are °C/°F and for Pressure are Bar/Psi.

Choosing the Coolant

The coolant (Water/ Ethylene Glycol) can be chosen on the Settings Menu. The Ethylene Glycol Percentage can be chosen once the EGW button is pressed. This selection limits the temperature set point value that the customer can select. Below are the temperature range for different glycol percentages. Note that selecting the correct coolant is the responsibility of the customer and should match what is filled in the system by the customer. Selecting the wrong coolant may cause damage to the equipment.

Water: 10°C to 40°C

10% Ethylene Glycol: 5°C to 40°C

20% Ethylene Glycol: 0°C to 40°C

30% Ethylene Glycol: -5°C to 40°C

40% Ethylene Glycol: -10°C to 40°C

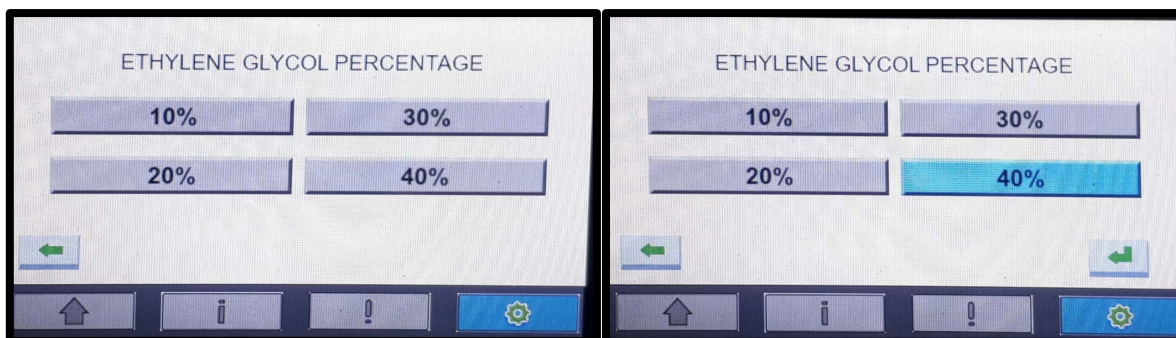

Figure 43 Choosing the Coolant

Customer Configurable Alarms

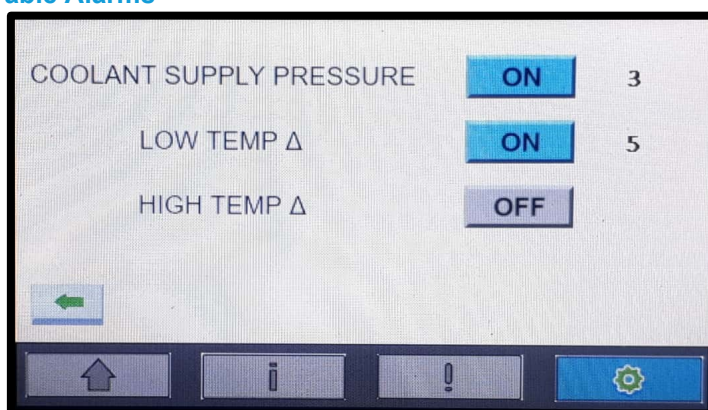

Figure 44 Setpoint Alarms

Alarms such as Coolant Supply Pressure, Low Temperature Δ and High Temperature Δ can be set in the Setting Menu. Each Alarm can be turned ON or OFF as required and the value can be changed by clicking on the number.

Coolant supply pressure

This secondary coolant supply pressure alarm is disabled by default. If the customer doesn't enable this alarm, then the unit would shut off according to the primary high coolant supply pressure value specified in [alarms table](#). If this alarm is enabled, the default value is 5 bar for this.

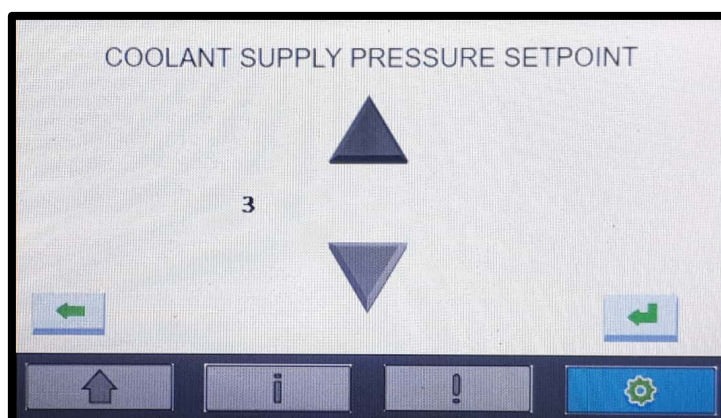

Figure 45 Coolant Supply Pressure

Low temp delta

This alarm is to alert the customer if the coolant supply temperature doesn't come within this specified deltaT from below the set point in a set amount of time. This alarm is disabled by default. If the customer enables this alarm, then the default value of delta T is 1 and default time is 30 minutes.

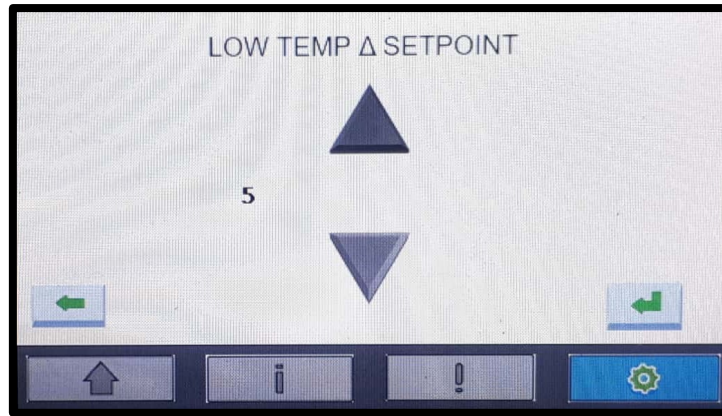

Figure 46 Low Temperature Delta

High temp delta

This alarm is to alert the customer if the coolant supply temperature doesn't come within this specified deltaT from above the set point in a set amount of time. This alarm is disabled by default. If the customer enables this alarm, then the default value of delta T is 1 and default time is 30 minutes.

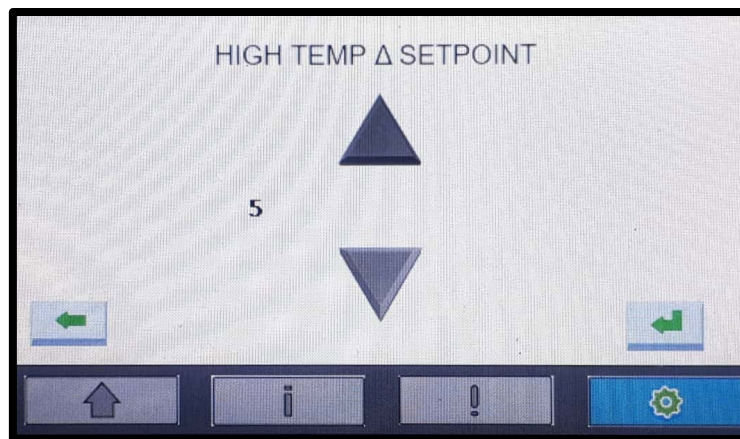

Figure 47 High Temperature Delta

Flow Settings

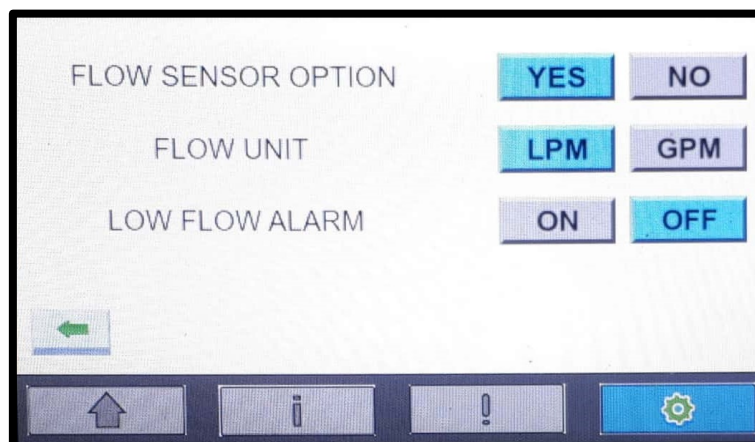
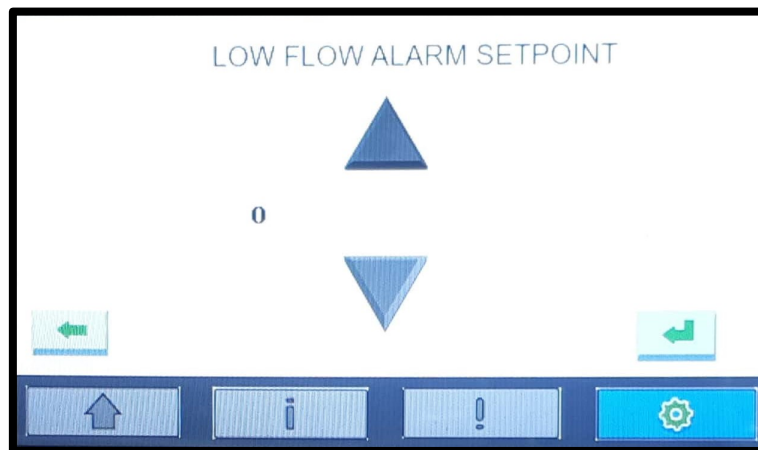
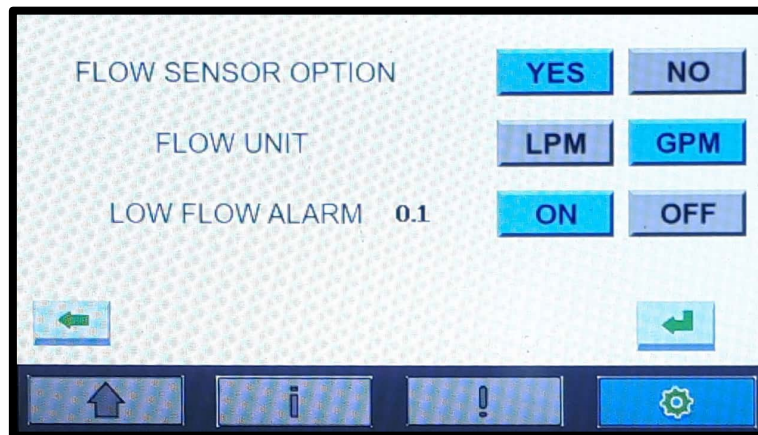

Figure 48 Flow Settings

If the optional system feature: Flow Control Kit, has been chosen along with the unit, the Flow Sensor option in Flow settings should be turned ON. Flow units can be chosen accordingly.

Low flow alarm can be either switched ON or OFF depending on customer selection. Once turned on, the value can be changed by clicking on the number.



Troubleshooting

For troubleshooting, use the following:

- Alarm status screen
- Plumbing & Refrigeration Diagram
- Troubleshooting table (below)

Issue	Possible Cause	Corrective Measures	Clearance By
Unit does not start	Power not applied. Electrical connection not correct or no mains connection	Check power supply and ensure proper voltage in the line. Check connection, insert mains plug.	Operator
	Coolant level too low. Alarm for low coolant will be active	Check coolant level and top off, if necessary. Refer to Adding Coolant	Operator
	Main switch not turned on	Turn main switch on	Operator
Unit running but cooling capacity is too low	Buckled or pinched coolant hoses	Install the hoses with a larger radius to avoid sharp bends.	Operator
	Improperly placed unit	Required clearance with the wall of the unit. Refer to Installation Requirements .	Operator
	Blocked Condenser	Clean condenser. Refer to Cleaning the Heat Exchanger .	Operator
	Coolant level too low	Check coolant level and top up, if necessary. Refer to Adding Coolant .	Operator
	Disconnected coolant hoses	Connect the coolant hoses. Refer to Connecting the Coolant Hoses .	Operator
	Dirty coolant filter	Clean or replace filter. Refer to Replace filter .	Operator
	No flow in cooling circuit	Refer to coolant high/low pressure alarm condition or optional low flow alarm condition.	Operator
	Fan does not rotate	Check to determine if the fan is rotating.	Operator
	Ambient air temperature too high	Operate unit within allowable ambient temperature range.	Operator
Refrigeration circuit not working properly	Confirm that all alarm conditions are cleared.	Operator	
Noise	Blocked cooling circuit	Ensure that cooling circuit is not blocked.	Operator
	Dirty coolant filter	Clean filter strainer. Refer to Replace filter .	Operator
	Blocked Condenser	Clean condenser. Refer to Cleaning the Heat Exchanger .	Operator

Alarms

* - **Red:** Critical with Stop, **Amber:** Notify, **Green:** Status

Alarm	Criticality	Alarm Description	Cause	Effect	Action Required/ Troubleshooting
Refrigerant	Red	Refrigerant compressor suction side pressure is higher than 14.5 bar. Alarm will reset after pressure drops below 9 bar.	Hot gas valve not closing (not functioning properly) or Thermal load on the system is too high or Unit has been sitting in high ambient before start-up	Compressor stops running, pump and condenser fan keep running.	Check if the unit has been sitting in ambient temperature above the specified operating temperature. If so, move the system to recommended operating ambient temperature and wait for few minutes for the system refrigerant to cool down. After fixing the above issue, acknowledge the alarm. This will clear the alarm on the LCD screen. Now run the unit. If the problem persists, contact LTS customer service.
	Red	Refrigerant Compressor suction side pressure is lower than 1.05 bar for more than 100 seconds. Alarm will reset after pressure is greater than 2 bar.	Possible refrigerant leak or Unit has been sitting in low ambient before first start-up	Turns off refrigeration loop. Pump keeps running	Check if the unit has been sitting in ambient temperature below the specified operating temperature. If so, move the system to recommended operating ambient temperature and wait for few minutes for the system refrigerant to warm up. After fixing the above issue, acknowledge the alarm on the LCD screen. This will clear alarm. If the problem persists, contact LTS customer service.
	Red	Refrigerant Condenser side pressure is higher than 20 bar. Alarm will reset after pressure drops below 11.5 bar.	Ambient temperature is high or Thermal load on the system is high or Condenser fan is not running or Condenser fan air flow is blocked	Compressor stops running, pump and the condenser fan keep running	Check if the ambient temperature is too high or above operating limits. Check if the load on the system is beyond the specified capacity for specific operating temperatures. Check if the air intake to the condenser fan is blocked or obstructed by something. After fixing the above issue, acknowledge the alarm. This will clear the alarm on the LCD screen. Now run the unit. If the problem persists, contact LTS customer service.
	Amber	Refrigerant Superheat is lower than 3.5°C for more than 18 seconds. Alarm will reset after Refrigerant Superheat is greater than 5°C.	Expansion valve not functioning properly	System keeps running normally	Acknowledge the warning alarm on the LCD screen. This should clear the warning. If the warning persists, contact LTS customer service.
	Amber	Refrigerant Superheat is higher than 23°C for more than 240 seconds. Alarm will reset after Refrigerant Superheat drops below 22.5°C	Expansion valve not functioning properly	System keeps running normally	Acknowledge the warning on the LCD screen. This should clear the warning. If the warning persists, contact LTS customer service.
	Red	Compressor suction side temperature sensor is not working properly	Compressor suction side temperature sensor is not working properly	If this happens during system start-up, unit will not Run. If this happens while the system is running, then the entire system shuts down.	Turn off the power switch to the unit off. Wait 5 seconds to turn the power switch on again and run the unit. If the problem persists, contact LTS customer service.

	Alarm	Criticality	Alarm Description	Cause	Effect	Action Required/ Troubleshooting
	Compressor condenser side pressure sensor failure	Red	Compressor condenser side pressure sensor is not working properly	Compressor condenser side pressure sensor is not working properly	If this happens during system stat-up, unit will not Run. If this happens while the system is running, then the entire system shuts down.	Turn off the power switch to the unit off. Wait 5 seconds to turn the power switch on again and run the unit. If the problem persists, contact LTS customer service.
	Compressor suction side pressure sensor failure	Red	Compressor suction side pressure sensor is not working properly	Compressor suction side pressure sensor is not working properly	If this happens during system stat-up, unit will not Run. If this happens while the system is running, then the entire system shuts down.	Turn off the power switch to the unit off. Wait 5 seconds to turn the power switch on again and run the unit. If the problem persists, contact LTS customer service.
	Compressor General Fault	Red	Compressor controller inputs faults detected by it to the main control board	Controller has detected faults in the compressor operation such as voltage, current, temperature, speed etc.	If this happens during system stat-up, unit will not Run. If this happens while the system is running, then the entire system shuts down.	Turn off the power switch to the unit off. Wait 5 seconds to turn the power switch on again and run the unit. If the problem persists, contact LTS customer service.
Coolant	Coolant supply pressure high	Red	Coolant supply pressure is higher than 4.1 bar. Alarm will reset after pressure drops below 3.5 bar.	Possible blockage in the coolant line	Entire system stops running	Check if there are any blockages or kinks on the coolant line. Check to make sure all the valves are open on customer installed connections. If the unit is equipped with a coolant filter, check if the filter needs replacement. After fixing the above issue, acknowledge the alarm on the LCD screen. This will clear the alarm. Now run the unit. If the problem persists, contact LTS customer service.
	Coolant supply pressure low	Red	Coolant supply pressure is lower than 0.5 bar. Alarm will reset after pressure is greater than 1 bar.	Possible leak in the coolant line	Entire system stops running	Check if there is any leakage on the coolant line. Check if the coolant level is low. After fixing the above issue, acknowledge the alarm. This will clear the alarm on the LCD screen. Now run the unit. If the problem persists, contact LTS customer service.
	Low fluid level	Red	Coolant fluid level is low.	Possible leak in the coolant line	Entire system stops running	Check to see if the coolant level is at the recommended level on the front fill port. Add coolant if necessary and acknowledge the alarm on the LCD screen. This will clear the alarm. Now run the unit. If the problem persists, contact LTS customer service.
	Coolant supply temperature sensor failure	Red	Coolant supply temperature sensor is not working properly	Coolant supply temperature sensor is not working properly	If this happens during system stat-up, unit will not Run. If this happens while the system is running, then the entire system shuts down.	Turn off the power switch to the unit off. Wait 5 seconds to turn the power switch on again and run the unit. If the problem persists, contact LTS customer service.

Alarm	Criticality	Alarm Description	Cause	Effect	Action Required/ Troubleshooting
Coolant supply pressure sensor failure	Red	Coolant supply pressure sensor is not working properly	Coolant supply pressure sensor is not working properly	If this happens during system stat-up, unit will not Run. If this happens while the system is running, then the entire system shuts down.	Turn off the power switch to the unit off. Wait 5 seconds to turn the power switch on again and run the unit. If the problem persists, contact LTS customer service.
Coolant supply high temp Δ	Red	Alerts the customer if the coolant supply temperature is not within certain pre-specified temperature delta above the temperature set point, within a specified amount of time after starting the unit or changing the set point	High load on the system than the specified capacity or ambient temperature is too high	Unit alarms to indicate customer the condition. Unit continues running.	Check if the ambient temperature is too high or above operating limits. If possible, check if the load on the system is beyond the specified capacity for specific operating temperatures. After fixing the above issue, acknowledge the alarm on the LCD screen. This will clear alarm. If the problem persists, contact LTS customer service.
Coolant supply low temp Δ	Red	Alerts the customer if the coolant supply temperature is not within certain pre-specified temperature delta below the temperature set point, within a specified amount of time, after starting the unit or changing the set point	Hot gas bypass heating loop is not functioning properly, or ambient temperature is too low	Unit alarms to indicate customer the condition. Unit continues running.	Check if the unit has been sitting in ambient temperature below the specified operating temperature. If so, move the system to recommended operating ambient temperature and wait for few minutes for the system refrigerant to warm up. After fixing the above issue, acknowledge the alarm on the LCD screen. This will clear alarm. If the problem persists, contact LTS customer service.
Coolant supply pressure High (secondary alarm)	Red	Alerts the customer if the coolant pressure is higher than the customer selectable pressure setting value.	Blocked coolant flow	Unit alarms to indicate customer the condition. Unit continues running until the high-pressure limit is reached	Check if there are any blockages or kinks on the coolant line. Check to make sure all the valves are open on customer installed connections. If the unit is equipped with a coolant filter, check if the filter needs replacement After fixing the above issue, acknowledge the alarm on the LCD screen. This will clear the alarm. If the problem persists, contact LTS customer service.
Low Flow Alarm	Red	Alerts the customer if the coolant flow rate falls below a pre-set value	Partially blocked coolant flow or coolant amount is too low or if coolant over current switch comes open and the pump shuts down creating a low coolant flow	Entire system stops running	Check if there are any blockages or kinks on the coolant line. Check to make sure all the valves are open on customer installed connections. If the unit is equipped with a coolant filter, check if the filter needs replacement After fixing the above issue, acknowledge the alarm on the LCD screen. This will clear the alarm. Now Run the unit. If the problem persists, contact LTS customer service.
Coolant supply high temperature	Red	Alerts the customer if the supply temperature exceeds 50°C. Alarm will reset when the temperature drops below 40°C	Coolant supply temperature is higher than 50°C	Unit alarms to indicate customer the condition. Compressor, pump and fan stop running	Verify the heat load has not exceeded the rating of the recirculating chiller. If the unit is still powered, check the alarm screen to find the referenced alarm in this table. After fixing the issue, acknowledge the alarm on the LCD screen. This will clear the alarm. Now run the unit. If the problem persists, contact LTS customer service.

	Alarm	Criticality	Alarm Description	Cause	Effect	Action Required/ Troubleshooting
	Coolant return high temperature	Red	Alerts the customer if the return temperature exceeds 50°C. Alarm will reset when the temperature drops below 40°C	Coolant return temperature is higher than 50°C	Unit alarms to indicate customer the condition. Compressor, pump and fan stop running	Verify the heat load has not exceeded the rating of the recirculating chiller. If the unit is still powered, check the alarm screen to find the referenced alarm in this table. After fixing the issue, acknowledge the alarm on the LCD screen. This will clear the alarm. Now run the unit. If the problem persists, contact LTS customer service.
Self-Test	Self-Test	Red	Controller checks whether all the sensors are functioning properly after the power switch is turned on	Sensors not connected properly or component failure	System will not Run if self-test fails	Check if there are any other alarms listed on the alarms page of the LCD screen along with this alarm. Check if those issues can be resolved using the guidelines above. After fixing the issue, acknowledge the alarm on the LCD screen. This will clear the alarm. Now Run the unit. If the problem persists, contact LTS customer service.

Communications Interface

Instructions for Setup

RS232 and RS485 serial communications are available. They are accessible via the DB-9 connectors on the rear of the chiller. Refer [Inadmissible Operating Conditions](#) to avoid any safety hazards. A Terminal Emulator or other comparable device will need to be connected to the DB-9 to allow command to be entered.

Terminal Settings: Baud Rate 115200, Data – 8-bit, Parity – none, Stop – 1 bit, Flow Control - none

Commands and responses:

Command	Description	General Response
CMP	Compressor on/off	Status of Compressor query (returns "ON/OFF")
COL	Set/Get Coolant type	Coolant Percentage (returns "xx")
CRT	Coolant Return Temp	Coolant Return Temperature query (returns "xxx.x C/F")
CSP	Coolant supply pressure	Coolant Supply Pressure query (returns "xx.xx bar/psi")
CST	Coolant Supply Temp	Coolant Supply Temperature query (returns "xxx.xx C/F")
CTL	Set/get control loop	System Control Loop [R {Run}, S {Stop}]
DAT	Set/Get date	Set/Get Date (returns "mm/dd/yy")
FCC	Fan duty cycle	Fan Duty cycle query (returns xxx.xx)
FLO	Set/Get flow option	Flow sensor Availability check (returns "1" if present, "0" if not present)
FLW	Get flow rate	Flow Rate query (returns "xx.xx LPM/GPM")
LVL	Coolant level sensor	Coolant Level Switch status query (returns "LOW", "OK")
MOD	Model	Displays the model number
PBP	Pressure bar/psi	Set Pressure in bar/psi (returns "bar/psi")
PMP	Pump on/off	Control Power to Pump [ON, OFF] (default = OFF)
RDP	Get R_CSP	Refrigerant Discharge Pressure query (returns "xx.xx bar/psi")
REF	Refrigerant type	Refrigerant type R513A
RSP	Get R_SSP	Refrigerant Suction Pressure query (returns "xx.xx bar/psi")
SCF	Degrees C or F	Select °C or °F [C, F] (default = C)
SSN	System serial number	Serial number is displayed
TIM	Set/Get time	Time [00:00:00-23:59:59] (default = 00:00:00)
TSP	Temp setpoint	Control Temperature Set Point [-10.0 to 40.0] (default = 20)
VER	Get firmware version	Version query (returns "FIRMWARE VERSION X.X")
XPM	Flow Rate Unit	Flow Rate Unit [GPM {Gallons per minute}, LPM {Liters per minute}] (default = LPM)

Command entry format

[\$[2-character source ID] [3 Character Command], [Data Field if required]

Command strings without contents in Data Field will be interpreted as a query.

Source ID

PC Serial link to a PC or external digital serial interface

Command Structure Examples

\$PCCST (Requests current Temperature of Coolant Supply Line via PC)

CST,25 (Response from controller reporting Coolant Supply Temperature)

\$PCVER (Returns [VER FIRMWARE VERSION x.x.x]) (Returns [CBS Firmware version x.x.x])

\$PCFLT,C (Clears Fault, Returns [FLT Faults Cleared])

System Maintenance and Service

Diligent maintenance is the prime factor for assuring an error-free and efficient operation of the unit. All the maintenance tasks contained in this chapter must be performed according to the maintenance intervals.

Safety

All safety and warning instructions must be reviewed completely by all personnel prior to maintenance work of the unit. Refer to [Safety Precautions](#).

Improper Maintenance



WARNING

Danger of injury due to improperly performed maintenance.

Improper maintenance can lead to personal injury or material damage.

- Disconnect the unit from all sources of power during maintenance work.
- Ensure that there is enough working area at the beginning of the maintenance work.
- Provide all components and tools required for maintenance work.
- Keep the working area clean and tidy. Loose components and tools, which are lying on each other or lying around, are sources of accidents.
- Check all components for soiling and damage. Do not use damaged or incorrect components.
- Handle the components with care, to avoid damage.
- Assemble components properly. Comply with specified screw tightening torques.
- Secure components, to prevent them from falling or tipping over.
- Only perform maintenance work using conventional tools. Improper or damaged tools can result in personal injury.

Handling Coolant



CAUTION

Danger of slipping or endangering the environment due to spilled coolant.

Spilled coolant can cause slipping and endanger those working in the environment.

- Do not spill coolant.
- Immediately remove the spilled coolant with an appropriate bonding agent.
- Dispose of the bonding agent and coolant mixture in accordance with regional regulations.

NOTE

Testing and replacing external coolant hoses.

Coolant hoses can become brittle through age and must be checked at regular intervals.

- Observe the specifications of the coolant hoses manufacturer.

Environmental Issues

NOTE

Danger to the environment due to improper handling

Environmentally conscious and anticipatory behavior of staff avoids environmentally hazardous impacts.

The following principles apply for environmentally conscious behavior:

- Environmentally hazardous substances must not get into the soil or into the drains. They should be kept in appropriate containers.
- Environmentally hazardous substances must be used and disposed according to regional regulations.
- When dealing with working fluids, remain aware of the safety data sheet of the corresponding manufacturer.

Personnel

Unless otherwise noted, all maintenance tasks described in this chapter can be performed by the operator of the unit.

Other maintenance tasks must be performed by specially trained qualified personnel. This is specially noted in the description of the single maintenance task.

Personal Protective Gear

The following personal protective gear for all maintenance work must be worn:

- Protective footwear
- Protective gloves
- Protective eyewear

Maintenance Schedule

Follow maintenance task described in table 3 to ensure proper operation of the unit.

The interval between maintenance are only recommendations and may vary depending on use of the unit and operating environment.

Table 3: Maintenance

Interval	Required Activities	Criteria	Personnel
Regularly	Clean heat exchanger. Refer to Cleaning the Heat Exchanger .	Plate fins and ventilation grids polluted	Skilled employee
	Check the coolant level and replenish it, if necessary. Refer to Adding Coolant and Priming Unit .	Coolant level at or below "Low" level	Operating personnel
	Inspect coolant hoses, connections and pipes for cracks and for leaks (visual inspection)	Coolant hoses, pipes and connections are leaking	Operating personnel
	Inspect the coolant quality (visual inspection)	Turbidity, airborne particles	Operating personnel
	Replace the coolant filter. Refer to Replacing the Coolant Filter .	Coolant supply pressure has increased over time	Operating personnel

Preparing the Unit for Maintenance

All necessary safety measures must be taken to prevent accidents when carrying out the maintenance. The following preparations must be made:

- Terminate the cooling operation.
- Let the unit and its coolant cool down to the ambient temperature.
- Switch off the unit.
- Disconnect the unit from the mains by pulling the mains plug.
- Secure the unit against being switched on again.
- Verify that the unit is de-energized.
- Keep unauthorized persons away from the working area.
- Place the unit on a level surface.

Verification of Safe State after Maintenance

- Visually inspect the refrigerant line to make sure there are no leaks.
- Ensure that all screws are securely fastened
- Make sure that there are no loose electrical connections.
- Ensure that the controller completes the diagnostic.

Draining Procedure

NOTE

Risk of Damage to the pump

When the coolant level in the coolant tank is too low and if it runs the pump dry, the pump can be damaged or destroyed.

- Avoid running the pump dry to prevent damage

Requirements

- Unit prepared for maintenance. Refer to [Preparing the Unit for Maintenance](#).
- Coolant hoses disconnected from the unit. Refer to [Disconnect Hoses](#).
- Coolant cooled down to the ambient temperature.

Required Tools and Materials

- Collection container/Hose – Note, unit holds approximately 5-9 liters of fluid.

Procedure

1. Make sure Drain Valve is closed.
2. Connect hose/Place collector container under the drain valve.
3. Open Drain Valve. (Position shown in Fig.)
4. Close Drain Valve once drained completely.

The coolant is now drained.

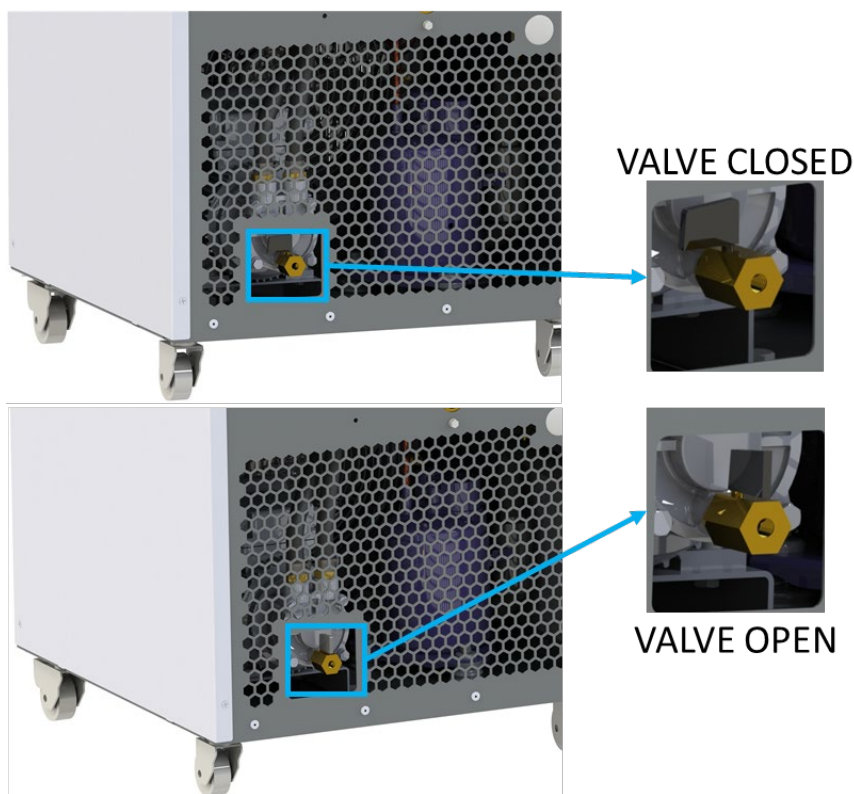

Figure 49 Draining the Coolant

Coolant Maintenance

Periodically inspect the coolant for contamination. Replace if the coolant becomes dirty/contaminated.

Replace filter

As filter ages, it will become clogged with particles and contamination. Visually inspect and replace filter as necessary. Refer to spare parts for filter part number.

Cleaning the Heat Exchanger

Cooling capacity is heavily reduced if the heat exchanger is contaminated. The heat exchanger must be checked for contamination (particulates) regularly and be cleaned, if required.

- ☐ The cleaning of the heat exchanger must be performed in accordance with the maintenance intervals.



DANGER

The use of water/chemicals for cleaning the heat exchanger can cause short circuit and damage the fan

The use of water/chemicals for cleaning the heat exchanger can damage the fan and result in a short circuit. In this case persons are in danger to get an electric shock.

- Do not clean the heat exchanger with water/chemicals.

NOTE

Damage to the fins of the heat exchanger due to improper handling of the unit.

Damaged fins of the heat exchanger lead to a reduced cooling capacity.

- Take care not to damage the fins of the heat exchanger when cleaning the heat exchanger.
 - Air pressure used to clean the fins must be controlled to prevent damage to the fins.
 - If the fins of the heat exchanger are not in a suitable condition, the unit must only be used again once the damage has been rectified.
-

Requirements

- Unit prepared for maintenance. Refer to [Preparing the Unit for Maintenance](#).

Required Tools and Materials

- Vacuum cleaner
- Compressed air pistol/pressurized air spray
- Hand brush
- Brush

Procedure

1. Clean the condenser and grill with a vacuum cleaner, or compressed air.
2. Care must be taken not to damage the fins.

Spare Parts

NRC1200 230V

Name	Part No.
Pump + motor 230V 50/60Hz	387002071-SP
Condenser Fan 230V	387003736-SP
Tank Cap	387002004-SP
Electronic Expansion Valve	387003734-SP
Electronic Expansion Valve Coil	387001942-SP
Hot gas bypass valve	387003727-SP
Hot gas bypass valve coil	387002838-SP
Refrigerant high-pressure sensor	387001977-SP
Refrigerant low-pressure sensor	387001976-SP
Coolant Pressure sensor	387001992-SP
Coolant Temperature sensor	387001969-SP
Optical level Switch assembly	387003497-SP
Main control board	387001951-SP
Power Board	387001952-SP
Compressor Controller	387001953-SP
Main Power Switch	387001961-SP
LCD Display assembly	387004426-SP
Flow meter	387004187-SP
Flow adjustment valve	387004180-SP
Filter Housing (includes filter)	387004178-SP
Filter Cartridge	387004497-SP
Casters locking	387002803-SP
Casters non-locking	387002804-SP
Compressor fuse 30A	387004338-SP
Pressure Switch	387005330-SP
Pump Overcurrent Switch	387006233-SP

NRC1200 120V

Name	Part No.
Pump + motor 120V 50/60Hz	387003987-SP
Condenser Fan 120V	387003989-SP
Tank Cap	387002004-SP
Electronic Expansion Valve	387003734-SP
Electronic Expansion Valve Coil	387001942-SP
Hot gas bypass valve	387003727-SP
Hot gas bypass valve coil	387002838-SP
Refrigerant high-pressure sensor	387001977-SP
Refrigerant low-pressure sensor	387001976-SP
Coolant Pressure sensor	387001992-SP
Coolant Temperature sensor	387001969-SP
Optical level Switch assembly	387003497-SP
Main control board	387001951-SP
Power Board	387001952-SP
Compressor Controller	387001953-SP
Main Power Switch	387001961-SP
LCD Display assembly	387004426-SP
Flow meter	387004187-SP
Flow adjustment valve	387004180-SP
Filter Housing (includes filter)	387004178-SP
Filter Cartridge	387004497-SP

Casters locking	387002803-SP
Casters non-locking	387002804-SP
Compressor fuse 30A	387004338-SP
Pressure Switch	387005330-SP
Pump Overcurrent Switch	387005152-SP

NRC2400

Name	Part No.
Pump + motor 230V 50/60Hz	387002071-SP
Condenser Fan 230V	387002821-SP
Tank Cap	387002004-SP
Electronic Expansion Valve	387002839-SP
Electronic Expansion Valve Coil	387001942-SP
Hot gas bypass valve	387002837-SP
Hot gas bypass valve coil	387002838-SP
Refrigerant high-pressure sensor	387001977-SP
Refrigerant low-pressure sensor	387001976-SP
Coolant Pressure sensor	387001992-SP
Coolant Temperature sensor	387001969-SP
Optical level Switch assembly	387003497-SP
Main control board	387001951-SP
Power Board	387001952-SP
Compressor Controller	387001953-SP
Main Power Switch	387001961-SP
LCD Display assembly	387004426-SP
Flow meter	387004187-SP
Flow adjustment valve	387004180-SP
Filter Housing (includes filter)	387004178-SP
Filter Cartridge	387004497-SP
Casters locking	387002803-SP
Casters non-locking	387002804-SP
Compressor fuse 30A	387004338-SP
Pressure Switch	387005330-SP
Pump Overcurrent Switch	387006233-SP

NRC5000

Name	Part No.
Pump + motor 230V 50/60Hz	387002071-SP
Condenser Fan 230V	387002007-SP
Tank Cap	387002004-SP
Electronic Expansion Valve	387002839-SP
Electronic Expansion Valve Coil	387001942-SP
Hot gas bypass valve	387002837-SP
Hot gas bypass valve coil	387002838-SP
Refrigerant high-pressure sensor	387001977-SP
Refrigerant low-pressure sensor	387001976-SP
Coolant Pressure sensor	387001992-SP
Coolant Temperature sensor	387001969-SP
Optical level Switch assembly	387003497-SP
Main control board	387001951-SP
Power Board	387001952-SP
Compressor Controller	387001953-SP
Main Power Switch	387001961-SP
LCD Display assembly	387004426-SP
Flow meter	387004187-SP

Flow adjustment valve	387004180-SP
Filter Housing (includes filter)	387004178-SP
Filter Cartridge	387004497-SP
Casters locking	387002032-SP
Casters non-locking	387002031-SP
Compressor fuse 50A	387006683-SP
Pressure Switch	387005330-SP
Pump Overcurrent Switch	387006233-SP

Decommissioning and Disposal

Temporarily Placing Out of Operation



DANGER



Electrical danger

Work on electrical installations may be carried out by trained and authorized electricians only.

- Switch off the unit before starting your work.
- Disconnect the unit from mains by pulling the mains plug.
- Secure the unit against being switched on again.
- Verify that the unit is disconnected.
- Carry out necessary earthing connections.
- Keep unauthorized persons away from the working area.

The decommissioned unit must be stored in a dry and dust-free room.



For recommended storage conditions, refer to [Storing the Unit](#).

Prior to Decommissioning

Procedure

1. Finish the cooling operation.
2. Disconnect the unit from mains.
3. Let the unit and the coolant cool down.
4. Disconnect coolant hoses from the unit. Refer to [Disconnect Hoses](#).
5. Drain the coolant. Refer to [Draining Procedure](#)
6. Clean the unit. Refer to [System Maintenance and Service](#).
7. Secure the coolant inlet and coolant outlet connections with protection caps against soiling.

The unit has now been decommissioned.

Returning the Unit to Service After Decommissioning

Procedure

1. Thoroughly clean the unit. Refer to [System Maintenance and Service](#).
2. Check that the unit is in operating condition.
3. Install the unit and put it into operation. Refer to [Installation Procedure](#).

Final Decommissioning or Disposal

Final decommissioning or disposal of the unit must be performed in accordance with the regulations of the country of use.

Contact Laird Thermal Systems to return end-of-life units through the official website at <https://www.lairdthermal.com/contact> or contact a company specializing in the disposal and recycling of equipment.

Disposal of Operating Materials

The operating materials of the unit can be hazardous to the environment and to health.

- Make sure the operating materials are disposed of or recycled according to local regulations.
- Also, the safety specifications of the coolant manufacturer must be obeyed.

Disposal of Refrigerant

Follow all applicable federal, state/provincial and local regulations for refrigerant disposal. The refrigerant used in the unit is classified to be slightly dangerous to groundwater and contains fluorinated greenhouse gas.

- Do not release into water sources or rivers/streams.
- Do not release into atmosphere.
- Storage only in approved containers.
- Waste disposal only by qualified contractors.

Always adhere to manufacturer safety requirements when handling operating supplies.

Return of the Unit to Laird Thermal Systems

Declaration of decontamination

Before re-shipment of the unit a declaration of decontamination must be sent to Laird Thermal Systems.

Return Procedure

All returns must be assigned a Return Materials Authorization number (RMA#) in advance. To start a return process, simply fill out the form at <https://www.lairdthermal.com/about/product-return-policy>

Returns received without RMA # may be refused. All returns must be securely packed to prevent shipping damage and must be clearly marked with the RMA# on the box. Consignor shall pay freight charges on all returns.

For any questions, please contact us via the website <https://www.lairdthermal.com/contact>

List of figures

Figure 1 Guards	11
Figure 2 Isometric Views of Unit	17
Figure 3 Top View	17
Figure 4 Front View	18
Figure 5 Rear View	18
Figure 6 Side Views	18
Figure 7 Marking on Unit.....	19
Figure 8 Labels on Unit.....	19
Figure 9 Coolant Filter Kit Part List	21
Figure 10 Bypass mode of Filter/Coolant Filter Kit assembled on Unit	21
Figure 11 Flow Control Kit Parts List	22
Figure 12 Assembly Instructions for Flow Control Kit	23
Figure 13 Flow Control Kit assembled onto Unit.....	23
Figure 14 Flow Control Kit with Coolant Filter Parts List	24
Figure 15 Assembly Instructions for Flow Control Kit with Coolant Filter	25
Figure 16 Flow Control Kit with Coolant Filter assembled on Unit.....	25
Figure 17 Minimum Clearance required for Unit Installation.....	32
Figure 18 Connecting Hoses.....	33
Figure 19 Disconnecting Hoses	34
Figure 20 Connecting Power.....	35
Figure 21 Refrigerant Circuit and Coolant Circuit	39
Figure 22 Coolant Circuit and Control Panel	39
Figure 23 Plumbing and Refrigeration Diagram.....	40
Figure 24 Thermal Performance of NRC1200 with Cooling Fluids: Water & 40% EG/W.....	41
Figure 25 Thermal Performance of NRC2400 with Cooling Fluids: Water & 40% EG/W.....	41
Figure 26 Thermal Performance of NRC5000 with Cooling Fluids: Water & 40% EG/W.....	41
Figure 27 Pump Performance of NRC1200 with Cooling Fluids: Water & 40% EG/W.....	42
Figure 28 Pump Performance of NRC2400 with Cooling Fluids: Water & 40% EG/W.....	42
Figure 29 Pump Performance of NRC5000 with Cooling Fluids: Water & 40% EG/W.....	42
Figure 30 NRC1200 Chiller Overall Dimensions.....	43
Figure 31 NRC2400 Chiller Overall Dimensions.....	43
Figure 32 NRC 5000 Chiller Overall Dimensions.....	44
Figure 33 Start-up Screen.....	45
Figure 34 Main Menu	45
Figure 35 Running Pump	46
Figure 36 Running the Machine.....	46
Figure 37 Sleep Screen	47
Figure 38 Information Screen	47
Figure 39 Alarm screen with no active alarms	48
Figure 40 Home screen with an active alarm.....	48
Figure 41 Acknowledging Alarms	48
Figure 42 Setting Menu.....	49
Figure 43 Choosing the Coolant	50
Figure 44 Setpoint Alarms.....	50
Figure 45 Coolant Supply Pressure	50
Figure 46 Low Temperature Delta	51
Figure 47 High Temperature Delta	51
Figure 48 Flow Settings	51
Figure 49 Draining the Coolant	62