



WL3004 Liquid to Air Cooling System

Specification and User Manual Version 1.6

387002779.02

Laird Thermal Systems s.r.o.
Prumyslová 497
462 11 Liberec
Czech Republic

Phone: +420 488 575 111

www.lairdthermal.com

Any information furnished by Laird and its agents, whether in specifications, data sheets, product catalogues or otherwise, is believed to be (but is not warranted as being) accurate and reliable, is provided for information only and does not form part of any contract with Laird. All specifications are subject to change without notice. Laird assumes no responsibility and disclaims all liability for losses or damages resulting from use of or reliance on this information. All Laird products are sold subject to the Laird Terms and Conditions of sale (including Laird's limited warranty) in effect from time to time, a copy of which will be furnished upon request.

© Copyright 2019-2021 Laird Thermal Systems, Inc. All rights reserved. Laird™, the Laird Ring Logo, and Laird Thermal Systems™ are trademarks or registered trademarks of Laird Limited or its subsidiaries.

Table of Contents

Revision History	5
1. About this Manual	6
1.1 Terms of Guarantee	6
1.2 Contact Information	7
2. Product Identification	8
2.1 Unit Specifications	8
2.2 Identification Plate	8
3. Safety Regulations	9
3.1 Hazard classes	9
3.2 Safety Symbols	9
3.3 Hints for Safe Operation	10
3.4 Prevent Hazards	10
3.5 Hints Regarding the Electrical Equipment	10
3.6 Environmental Issues	11
3.7 Safety Equipment	11
3.8 Safety and Signaling Equipment included in the Unit	11
3.9 Guards	12
3.10 Caution Labels	12
3.11 In Case of Accidents	13
4. Product Description	14
4.1 Intended Use	14
4.2 Use not in Conformance with the Intended Use	14
4.3 Unit Components	15
4.4 Cooling Circuit	15
4.5 Specifications	16
Dimensions and weight	16
Performance data	16
Environmental conditions	16
Settings	16
4.6 Setting-up Requirements	17
4.7 Infrastructure	17
5. Transport	18
5.1 Safety Indications for Transportation and Setting-up	18
5.2 Transportation of the Unit	18
5.3 Unpacking	18
6. Initial Operation	19
6.1 Safety Indications Related to Initial Operation	19
6.2 Setting to Work	19
6.3 Cooling Circuit Connection and Filling	20
6.4 Electrical Connections	21

6.5 Carrying out Setting to Work	22
6.6 Daily Start-up	22
6.7 Setting to work after Storage	22
7. Controlling the Unit.....	23
7.1 Safety Indications for Controlling the Unit.....	23
7.2 Switching on the Unit	23
7.3 Switching off the Unit	23
7.4 Settings	24
7.4.1 Flow control device	24
7.4.2 By-pass valve	24
7.4.3 Setting the Thermostat.....	24
8. Disruptions	25
8.1 Disruption in Operation	25
8.2 Trouble Shooting.....	25
9. Maintenance and Cleaning.....	26
9.1 Maintenance Schedule.....	26
9.2 Cleaning of Heat Exchanger	26
9.3 Refilling of Coolant.....	26
9.4 Cleaning of Strainer	27
9.5 Cleaning of Unit Casing	28
10. Repair	29
11. Dismounting, Disposal, Storage.....	30
11.1 Temporary Placing out of Operation	30
11.2 Re-packaging of the unit	31
11.3 Storing the Unit	31
11.4 Disposal	31
11.5 Disposal of Operating Materials	31
11.6 Return of the unit to Laird Thermal Systems	31
12. Wear Parts and Spare Parts	32
Addendum.....	34
Flow scheme	34
Wiring diagram	35

Revision History

REV	DATE	DESCRIPTION	NAME	Page
1.0	31-Jul-19		Henrik Olsson	
1.1	22-Mar-19	Set point of temperature switch changed from 55°C to 45°C.	Jonathan Knutsson	16
1.2	22-Apr-20	Document template updated to LTS format, spelling errors corrected.	Maria Mjalgard	
1.3	26-Nov-20	Updates for unit label and Chapter 6. Setting to work.	Markus Nyman	8, 20-21
1.4	22-Jul-21	Removed Declaration of Conformity Document (This is unique for each unit) Updated minor formatting changes	Maria Mjalgard	
1.5	04-NOV-21 02-FEB-23	Text correction – removed “non-variable”. Set point of temperature switch changed from 45°C to 55°C. Spare parts list updated	Ales Chomat	11, 16
1.6	10-Aug-23	Updated part number	Saad El Fadali	

1. About this Manual

This document is the English translation of the original Operation Manual in German language for the Water-Air Cooling Unit WL 3004 (called unit in the following). It is based on German safety regulations. In your country other regulations may apply.

This Operational Manual addresses the needs of the user of the unit. Its intention is to allow the safe operation of the unit. Thus, it should be read carefully and be kept in a space accessible for the users of the unit at any time.

All chapters of this Operation Manual can be read independently and thus can be used for look-up purposes.

1.1 Terms of Guarantee

General sale and delivery terms of LAIRD apply. The buyer accepts these terms, at the latest when signing the contract of purchase.

The particular terms of guarantee and duration of guarantee of the unit in question can be taken from the contract documents as well as from the order confirmation.

Warranty claims and liability are excluded in case of one of the following situations:

- Use of the unit in an unintended way
- Inaccurate installation, putting into service, operation, repair or maintenance of the product by people that are not fully authorized
- Use of the product despite of defect, wrongly implemented or non-functional safety units or protective gear
- Unauthorized or forbidden modifications by the user concerning the electrical equipment of the unit
- Unauthorized or forbidden modifications by the user concerning the mechanical structure of the unit
- Unauthorized or forbidden modifications by the user concerning the operating parameters
- Use of unauthorized tools
- Use of unauthorized operating supplies
- Exceedance of mandatory maintenance intervals
- Cases of disaster caused by foreign matter influence or act of nature beyond control

NOTE

Any form of unintended use of the unit and any structural change caused by the user without prior authorization in written form by Laird Thermal Systems will lead to the termination of warranty as well the termination of the declaration of conformation and will free Laird Thermal Systems from product liability. This concern includes safety devices as well.

In case of authorized changes or when adding optional equipment, it is the sole responsibility of the customer to assure the accurate implementation of the required safety devices.

1.2 Contact Information

If you have questions with respect to this unit please use the contact information given below. Always communicate the following:

- Your name and address
- Name of contact at your address
- Product data as on identification plate: Type of unit, serial number and year of manufacture

Company contact:

Laird Thermal Systems s.r.o.
Prumyslová 497
462 11 Liberec

Czech Republic

2. Product Identification

2.1 Unit Specifications

Manufacturer	Laird Thermal Systems GmbH
Type of product	Water-air cooler
Type of unit	WL 3004
Article number	387002779.02

Table 1: Unit specifications

2.2 Identification Plate

The identification plate is attached to the front side of the unit (see Fig. 1).

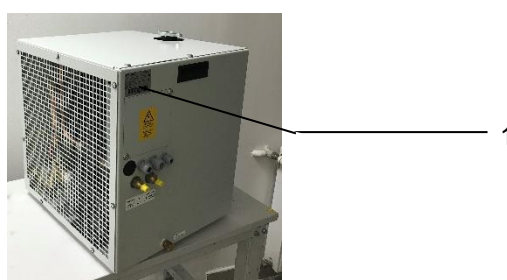

Fig. 1: Position of identification plate

1	Identification plate
---	----------------------



Fig. 2: Unit specific identification plate

1	Unit type	2	Article number
3	Serial number	4	Electrical specifications
5	Date of manufacture		

3. Safety Regulations

3.1 Hazard classes

In this document safety instructions are using standardized representation and symbols. Depending on the probability of their incidence and the severances of consequences three hazard classes are used



DANGER



Reference to direct danger for humans.

Inobservance will lead to irreversible injuries or exitus.



CAUTION

Reference to noticeable danger for humans or possible damage to property.

Inobservance may lead to reversible injuries or to damage to property.

3.2 Safety Symbols

In this Operation Manual concrete safety instructions are given in order to point out unpreventable residual risks when operating the unit. These risks include danger for

- Human beings
- The unit and other equipment
- The environment

The safety symbols used in this manual are indicated below. The main reason for their use is to point the reader to the safety instruction given in the text field beside.



Symbol	Meaning
	Warning with respect to general danger or damage to property
	Warning with respect to electrical hazard

Table 2: Warning signs

Symbol	Meaning
	This symbol indicates that disconnecting from mains is required.

Table 3: Signs giving orders

3.3 Hints for Safe Operation

NOTE

Conduct inspections on a regular time base!

This will ensure that the appropriate measures will be carried out indeed.

The unit is operational save. It was built according to the existing state of technology.

Despite this the unit could cause hazards if it

- is used in a way it was not intended for
- is used improperly
- is operated under unsuitable conditions

3.4 Prevent Hazards

Hazards can be prevented by safety-conscious and anticipatory behavior of staff.

Everybody working with the unit should keep the following in mind:

- Make this Operation Manual available for everybody at the operational location of the unit in a complete and perfectly readable form!
- Use the unit exclusively for what it was intended!
- The unit must be operational and error free. Check the condition of the unit before working with it and within a regular time frame!
- Make sure that nobody can injure himself by any part of the unit!
- Any disruption or recognizable change concerning the unit should be reported to the responsible person!
- Stick to the accident prevention regulations as well as any regional regulations!

3.5 Hints Regarding the Electrical Equipment



DANGER



Danger to life through electrical shock when working on the electrical equipment of the unit!

- Switch off the unit before starting your work!
- Disconnect the unit from mains by pulling the mains plug!
- Verify that the installation is dead (volt-free)!
- Carry out earthing or short circuiting!

When working on electrical installations the following principles should be observed:

- Works on the electrical installations may only be accomplished by qualified electrical staff!
- When connecting electrical equipment to mains regional regulations must be observed. Be aware of the information in the wiring diagram!
- The unit is powered by electricity. Electrical shock hazard exists, if the electrical installations are defective or the insulation fails during operation.
- When switched off the unit is not disconnected from mains. This is only the case when the mains plug is pulled.
- Any changes regarding the control elements of the unit can have an influence on the safe operation. All intended changes must be authorized by the manufacturer.
- After the implementation of a change the safeguard operations must be verified.
- No unauthorized changes on the unit are allowed. All intended changes must be authorized by the manufacturer.

3.6 Environmental Issues

Environmentally conscious and anticipatory behavior of staff avoids environmentally hazardous impacts.

The following principles apply for environmentally conscious behavior:

- Environmentally hazardous substances must not get into the ground or the drains. They should be kept in appropriate containers.
- Environmentally hazardous substances must be fed to utilization or disposal according to regional regulations.

When dealing with operating supplies always keep aware of the safety data sheet of the corresponding manufacturer.

3.7 Safety Equipment

NOTE

The safety equipment listed below must be integrated in the local control environment by the customer, unless otherwise noted. These works must be carried out only by trained experts. All required information can be taken from the wiring diagram shown in the addendum.

Safety equipment must not be modified, removed or taken out of operation. All parts of the safety equipment must be accessible at all times.

3.8 Safety and Signaling Equipment included in the Unit

The unit is equipped with safety equipment at critical spots (see Fig. 2)

- The water throughput is controlled by a flow control device that must be integrated in the potential-free safety circuit of the device to be cooled.
- The maximum temperature of the cooling circuit is controlled by thermostat with an opener contact that must be integrated into the safety circuit of the device to be cooled.
- The maximum pump pressure is limited by a safety valve that by-passes the liquid stream when the pressure pre-set is exceeded.

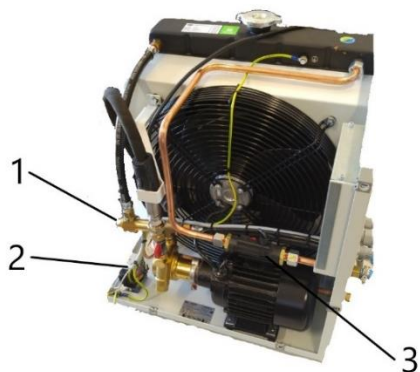

1	Safety valve	2	Thermostat
3	Flow control device		

Fig. 3: Safety equipment

3.9 Guards

Direct access to hazardous parts or areas of the unit is restricted by the unit cover. The cover may only be removed for the purpose of maintenance or repair works and shall be replaced prior to taking the unit back into operation. The unit cover is fixed by 8 screws. The left-side panel can be removed independently from the main cover by opening 7 quarter-turn fasteners. The electrical terminal area is accessible after removing the corresponding plate on the front side held by two screws. For unscrewing/screwing or opening/closing of the fasteners a 7.0 x 1.0 mm slotted screwdriver is required.



Fig. 4: Guards

1	Unit cover	2	Removable side panel
3	Access plate for electric terminal block		

3.10 Caution Labels

Danger spots on the unit are indicated corresponding to German safety regulation BGV A8 "Sicherheits- und Gesundheitsschutzkennzeichnung am Arbeitsplatz".

Caution labels on the unit must be easily readable at all times. Illegible caution labels must be exchanged without delay.

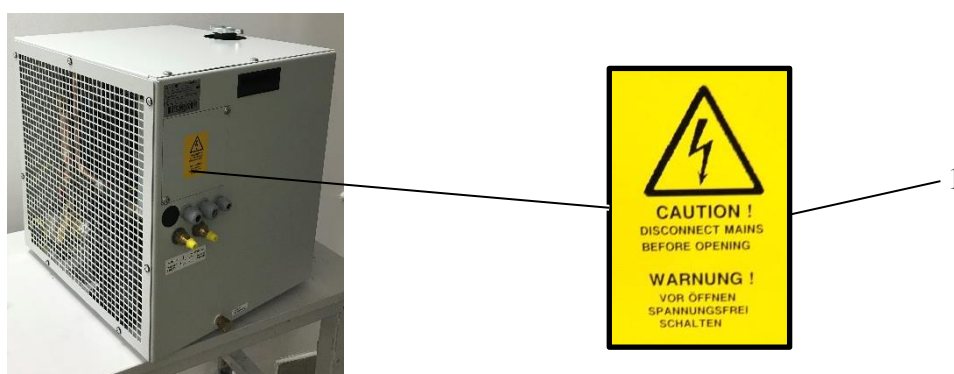

Fig. 5: Caution labels on the unit

1	Hint on electrical hazardous area behind access plate
---	-------------------------------------------------------

3.11 In Case of Accidents

Should you or another person be injured when working with the unit:

- Stay calm!
- Render first aid!
- Call the company first-aider without exception!

4. Product Description

4.1 Intended Use

The water-air cooler WL 3004 is used for the cooling of a water circuit. As a coolant water or a water/glycol mixture may be used. The coolant circulates between the cooling unit and the device to be cooled. It is re-cooled by an air-cooled heat exchanger. The maximum cooling capacity depends on the difference between the ambient temperature and the temperature of the coolant forward flow. Its value is 3000 Watts for a temperature difference of 12 K.

The unit is exclusively intended for use in industrial and commercial environments.

The intended use also includes the observance and following of all hints given in this Operation Manual.

4.2 Use not in Conformance with the Intended Use

Operation of the unit under improper operational conditions is not allowed, since otherwise the operation safety cannot be granted.

When using the unit in a way not compliant with the intended use, hazardous situations may occur.

Operation of the unit is not allowed under the following conditions:

- The unit is used for a purpose other than the one it is intended for.
- The unit or parts of it are damaged, the electrical installation is not correct or the insulation is broken.
- Protective or safety equipment is not functional or defect, improperly installed or missing.
- The unit is not working properly.
- Controlling devices were modified in a way that is not permitted.
- Operational parameters were changed in a way that is not permitted.
- Operation in areas exposed to explosion hazards
- Operation with cooling media not according to specification
- Use of unauthorized tools
- Exceedance of the compulsory maintenance intervals

NOTE

The manufacturer is not liable for damage occurring when using the unit in a way it was not intended for. When using the unit in a way it was not intended for, the manufacturer's warranty given by Laird Thermal Systems will expire.

4.3 Unit Components

Additional information can be retrieved from the flow scheme shown in the addendum. The unit consists of the following main components:

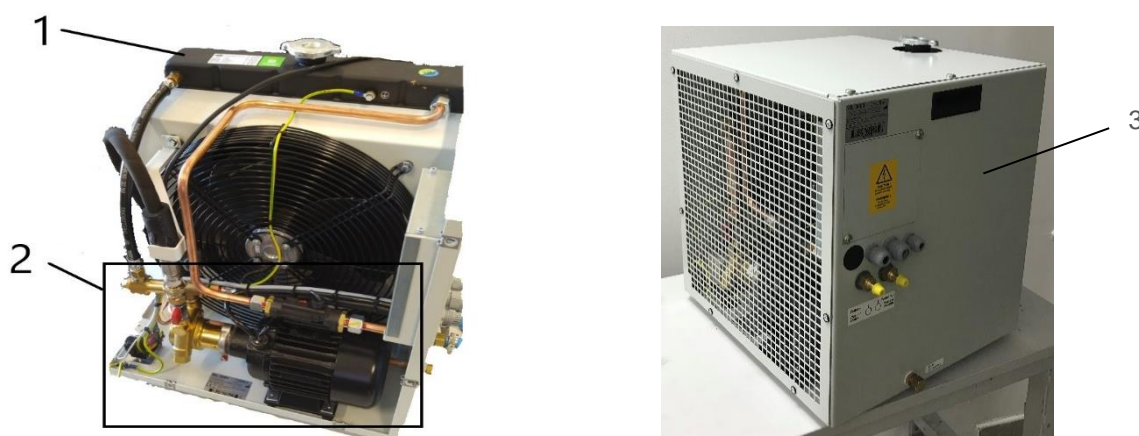

Fig. 6: Main components

1	Coolant container and heat exchanger	2	Cooling circuit
3	Casing		

4.4 Cooling Circuit

In the cooling circuit the coolant is driven by the pump to the device that is to be cooled and back via the return flow. The heat is dissipated into the ambient air by an air-cooled heat exchanger. Exceedance of the maximum pump pressure is prevented by a by-pass circuit.

The water temperature is controlled by an electric thermostat, whereas water throughput is controlled by a flow control device. Both indications are made potential-free and must be integrated into the safety circuit of the device to be cooled.

4.5 Specifications

Dimensions and weight

Length:	444 mm (w/o hose nipples)
Width:	398 mm
Height:	481 mm
Weight:	38.5 kg (empty)
Coolant capacity:	3.7 liters

Table 4: Dimensions and weight

Performance data

Cooling capacity:	3.0 kW
Throughput:	> 6.0 lpm at 6.0 bars
Mains voltage:	230 VAC, 50/60 Hz
Current draw:	2.5 A

Table 5: Performance data

Environmental conditions

Operating temperature:	+5°C ... +40°C
Storage temperature:	-25°C ... +70°C (empty)
Relative humidity:	20% ... 80%

Table 6: Environmental conditions

Settings

Flow control device	4.0 ± 0.1 lpm (opening threshold)
Thermal switch	55°C ± 5°C
Maximum pressure	8.0 ± 0.5 bars

Table 7: Settings

4.6 Setting-up Requirements

Installation Location

- The location must be even.
- When choosing the installation location, the following must be kept in mind: the air flow of the cooling air must not be restricted, forward and back flow connections must be easily accessible and all tubes must be installed without sharp bends.

Environmental Conditions



CAUTION

Risk of damage through unsuitable environmental conditions.

Damage to property and corrosion damage may result and are not covered by manufacturer's liability.

- The unit is only authorized for use in indoor environments.
- The unit must not be stored or operated in aggressive, humid environments.
- The unit must not be stored or operated outdoor.

Pay attention to the environmental conditions as given in the specifications on page [16](#).

4.7 Infrastructure

The following infrastructure is required for connecting the unit:

Parameter	Rated value
Operating voltage	230 VAC

Table 8: Required infrastructure

5. Transport

5.1 Safety Indications for Transportation and Setting-up



CAUTION

Risk of injury by lifting the unit!

The weight of the unit is almost 40 kg.

- Do not lift the unit manually!
- Always use proper auxiliary means such as a forklift or a jack lift!

5.2 Transportation of the Unit

The unit is delivered wrapped in foil on a transportable pallet. Leave the unit on the pallet until bringing it into service. Use a forklift or jack lift for transportation to the installation location.

5.3 Unpacking

Remove the foil before setting up the unit!

Inspect the unit regarding:

- Damage caused by transportation
- Completeness of delivery

Lift the unit with a forklift or jack lift off the transportable pallet.

Dispose of the packaging material in accordance with regional regulations.

NOTE

Laird Thermal Systems advises to keep the transportable pallet for later transportation of the unit.

6. Initial Operation

6.1 Safety Indications Related to Initial Operation



CAUTION

Danger of malfunction caused by faulty connections during initial operation!

Before switching on the unit make sure that

- all safety equipment of the unit is implemented and functional
- all connections were properly made

Please follow the rules in chapter Safety Regulations on page [9](#).

6.2 Setting to Work

Placement



Fig. 7: Minimum clearance for air entrance and air exit

1	Ventilation grid
---	------------------

- 1) Move the unit to its installation location as mentioned in chapter [5](#).
- 2) Place the unit in a way that air entrance and air exit are not obstructed. Wall clearance must not be less than 0.5 m, otherwise cooling capacity may be restricted.

NOTE

In case of storage of the unit at temperatures lower than 5°C or higher than 40°C for longer periods please wait 3 hours prior to initial operation to allow for temperature adjustment.

6.3 Cooling Circuit Connection and Filling



CAUTION

Risk of damage by using improper cooling hoses!

This may lead to damage to persons, damage to the unit or corrosion damage.

- When choosing cooling hoses pay attention to sufficient burst strength and compatibility with coolant!
- Only use cooling hoses without any signs of damage!

The cooling hoses with an internal diameter of 9 mm are connected to the unit by means of hose nipples. Water outlet and water inlet are indicated with respective symbols.

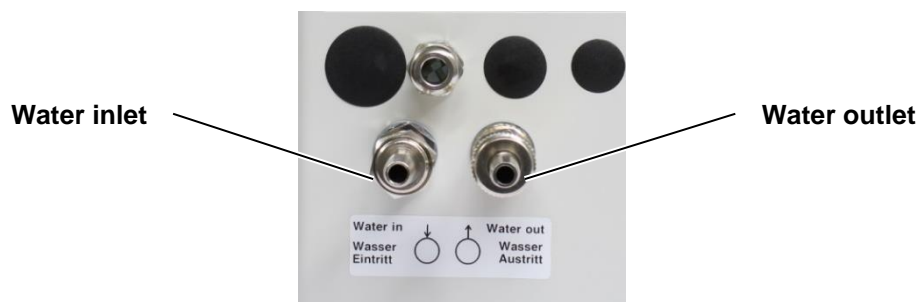

Fig. 8: Labeling of water inlet and water outlet

- 1) Connect a suitable hose to the hose nipples for water inlet and water outlet and secure it with a clamp respectively.
- 2) Connect the hoses to the corresponding nipples of the device to be cooled.

NOTE

When connecting the cooling hoses pay attention to flow direction. Follow the documentation released by the manufacturer of the device to be cooled.

Transparent hoses stimulate algae growth that may increase the error-proneness of the components built into the unit. Thus, only use non-transparent hoses.

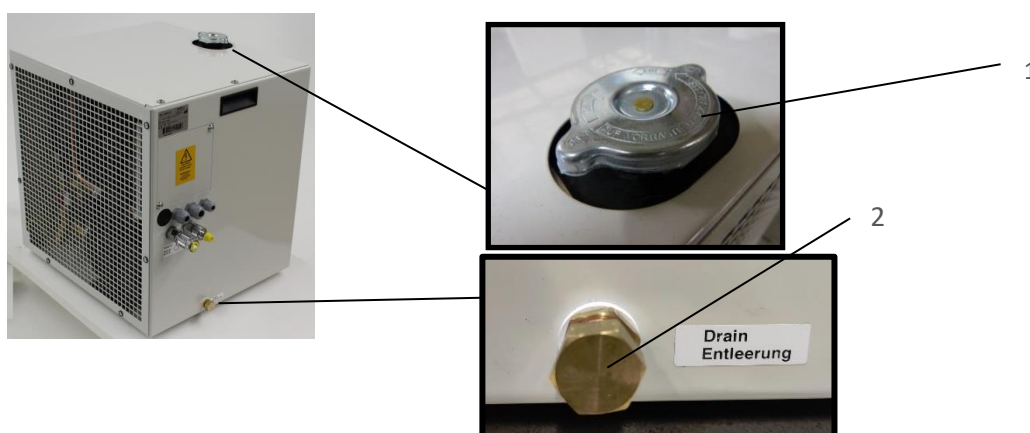

Fig. 9: Cap of coolant container

1	Cap
2	Drain port with cap

- 3) Open the coolant container by removing the cap.
- 4) Fill the coolant container with about 1 liter of water or water/glycol mixture.
- 5) Open the drain port cap using a 19mm Spanner and slightly let air out by opening the rubber sealing in the top, close the cap tight when done. Some liquid could also come out so take precautions.
- 6) Fill additional water or water/glycol mixture into the container until reaching the top (usually 2.5-3.5 liters).
- 7) Close the coolant container by fitting the cap.

6.4 Electrical Connections



DANGER



Danger to life through electrical shock when working on the electrical equipment of the unit!

- Switch off the unit before starting your work!
- Disconnect the unit from mains by pulling the mains plug!
- Verify that the installation is dead (volt-free)!
- Carry out earthing or short circuiting!



CAUTION

Risk of damage through improper connections!

Improper integration of the unit into the safety circuit of the device to be cooled will lead to the inoperativeness of the safety equipment listed in chapter 3 on page 11.

- All connections required must be incorporated according to the wiring diagram shown in the addendum.
- Ensure yourself that all connected safety equipment is properly functioning.
- All works should be carried out only by expert.

NOTE

The unit is delivered without a mains cable. The electrical connection as well as the integration into the safety circuit of the device to be cooled are the customer's responsibility and must be accomplished by expert staff.

Required information can be drawn from the specifications listed on page 16 and the wiring diagram in the addendum.

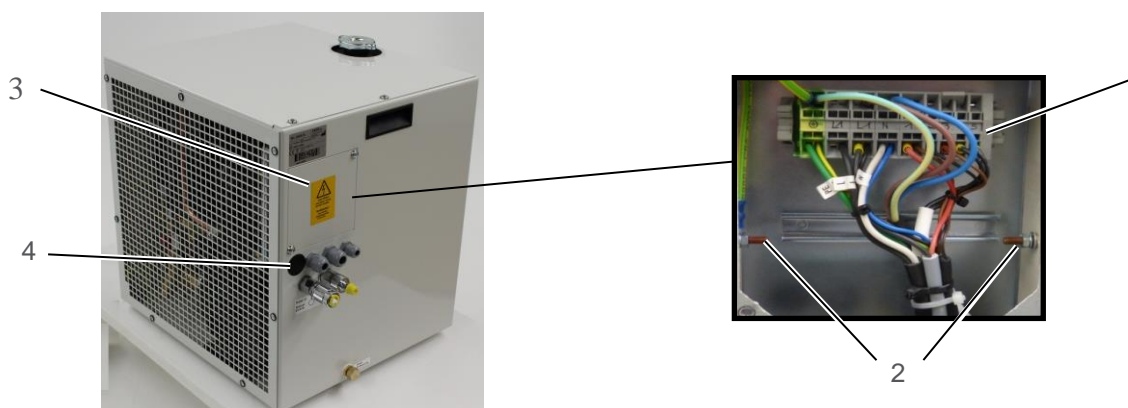

Fig. 10: Electrical connections and terminal behind access plate

1	Electric terminal stripe	2	Earth bolt M5
3	Access plate	4	Cable bushings

- 1) Remove the access plate after unscrewing the 2 screws.
- 2) Feed the mains cable through one of the cable bushings and make the connection to the terminal. Then do the same with the wires for the implementation of the safety circuit.
- 3) Remount the access plate.

After installation of the mains cable connect the unit to mains by inserting the mains plug or making a mains connection as required by the situation.

6.5 Carrying out Setting to Work

After connecting the cooling circuit, filling the coolant container and finishing the electrical connections follow the steps below for setting the unit to work:

- 1) Remove the cap on the coolant container.
- 2) Switch on the unit and let it run for about 10 minutes in order to fill and vent the cooling circuit. Continuously check the filling level during this procedure.



CAUTION

Lack of coolant may destroy the pump!

When looking into the filling plug of the coolant container the filling level must always be above the heat exchanger fins.

- 3) If required, refill coolant.
 - 4) Check the compliance with the operational parameters as specified on page [16](#).
 - 5) Remount cap on coolant container.
 - 6) Switch off the unit.
- ⇒ The unit is ready for operation.

6.6 Daily Start-up

Switch on the unit about 1 minute prior to using the equipment that is to be cooled.

6.7 Setting to work after Storage

Setting to work after storage will have to follow the same procedures as required for initial operation (see chapter [6](#)).

7. Controlling the Unit

The unit is controlled using the controls of the equipment that is to be cooled.

All alarm and error signaling is only indicated on the control panel of the equipment that is to be cooled.

7.1 Safety Indications for Controlling the Unit



CAUTION

Lack of coolant may destroy the pump!

- Operate the unit only when the filling of coolant container is sufficient!
- Check the filling level of the coolant container regularly!

Also pay attention to the hints given in the chapter Safety indications on page [9](#).

7.2 Switching on the Unit

- The unit is ready for switching on.
 - 1) Switch on the unit about 1 minute prior to operation of the device to be cooled using the appropriate control of that device.
 - 2) Check the compliance with the operational data according to the specifications listed on page [16](#).
- ⇒ The unit is running.

7.3 Switching off the Unit

- Cooling operation has come to an end.
 - 1) Switch off the unit using the control of the device to be cooled.
 - 2) Close all valves that may exist in the extension of the hoses running to and from the unit.
- ⇒ The unit is out of operation.

7.4 Settings

NOTE

The flow control device and the by-pass valve are set according to specification and sealed. Any modifications to these settings lie in the sole responsibility of the customer and must only be carried out by expert staff.

The adjustment of the flow control device should not be made without the help of proper measuring equipment, as the switching point must be set in a controlled way. Otherwise the function of the safety circuit might not be reliable and, as a result, the device to be cooled might get damaged.

7.4.1 Flow control device

The flow control device contains a closing contact whose OFF threshold is pre-set to a throughput of 4.0 liters per minute. For setting the switching point the switch head must be adjusted. For that purpose, the screw retained by red locking varnish must be released and the switching head must be moved while the throughput change is monitored by means of the equipment implemented for that purpose. After setting the switching point the head fixing screw must be tightened firmly again.

7.4.2 By-pass valve

The by-pass valve is set by the manufacturer to a maximum pressure of 8 bars. If any modification to this setting should be required, please contact the Laird Thermal Systems service department to receive briefing.

7.4.3 Setting the Thermostat



Fig. 11: Thermostat

1	Knob of thermostat
---	--------------------

The unit is delivered by the manufacturer with the thermal switch being set to 55°C. The thermal switch can be adapted to meet changing needs.

Increase the temperature setpoint

2) Turn the knob clockwise.

⇒ The switch-off temperature is set to a higher value.

Decrease the temperature setpoint

3) Turn the knob counter-clockwise.

⇒ The switch-off temperature is set to a lower value.

8. Disruptions

8.1 Disruption in Operation

The most common reason for disruption in operation of the unit is improper maintenance. Maintenance should be carried out regularly according to the intervals defined on page [27](#).

In case of disruption start with checking the following:

- Fan polluted or blocked?
- Coolant polluted?
- Low coolant contents because of leakage, evaporation or an extended cooling circuit with long hoses?

More help can be found in the following paragraph.

In case you do not succeed in identifying the problem cause by means of this manual please contact the service department of Laird Thermal Systems.

8.2 Trouble Shooting

For trouble shooting you may rely on the following:

- Alarm signaling within the safety circuit of the device to be cooled
- Wiring diagram
- Flow scheme
- Trouble shooting table given below

Problem	Possible reason	Countermeasure
The unit does not start	Electrical connection not correct or no mains connection	Check connection, insert mains plug, check main power switch
The unit is running, but cooling capacity is not available or too low	External hoses sharply bent?	Pay attention to smooth bends, when hoses are connected
	Unit properly located?	Clearance to walls not less than 0.5 m
	Is there flow in cooling circuit?	Flow is signaled potential-free by the safety equipment of the unit and can be visualized in the range of controls of the device to be cooled.
	Contents in coolant container low	Check coolant level, refill coolant if necessary → page 22
	Fan turning?	Cover the ventilation grid next to the fan with a sheet of paper. If the paper is sucked and hold by the airflow, the fan works properly.
	Ambient temperature too high?	Check specifications → page 16
Noisy unit	Contents in coolant container low	Refill coolant

Table 9: Trouble shooting list

9. Maintenance and Cleaning

Diligent maintenance is the prime factor for assuring an error-free and efficient operation of the unit. Operating personnel can perform these tasks when properly trained.

9.1 Maintenance Schedule

Device	Activity	Interval	Criteria	Tools	Performer
Heat Exchanger	Clean	Minimum weekly (if required, daily)	Plate fins and ventilation grids not polluted	Slotted screw driver 7 x 1 mm, compressed air, vacuum cleaner	Operating personnel
Coolant container	Check filling	Weekly	Coolant level well above mesh	Visual inspection	Operating personnel
Strainer	Clean, replace if required	Every 3 months, more often when coolant polluted	Strainer undamaged and clean	Metric AF24 wrench, cloth or vessel	Operating personnel

9. Maintenance schedule

9.2 Cleaning of Heat Exchanger

Cooling capacity is heavily reduced, if the heat exchanger is polluted. The heat exchanger must be checked for pollution regularly and be cleaned if required.

For cleaning the heat exchanger follow these steps:

- 4) Disconnect the unit from mains.
- 8) Remove the side panel and the unit cover.
- 9) Clean the heat exchanger using compressed air opposite to the direction of air entrance into the unit (i.e. from the inside out). Be careful in order not to damage the plate fins.
- 10) Remove any pollution from the ventilation grid and the side panel using a vacuum cleaner.
- 11) Remount the unit cover and the side panel.

⇒ The unit is ready for operation.

9.3 Refilling of Coolant

Since the cooling circuit is an open circuit, evaporation of coolant may occur. Thus, the filling level of the coolant container must be checked regularly and coolant might have to be refilled as described on page 22.

9.4 Cleaning of Strainer

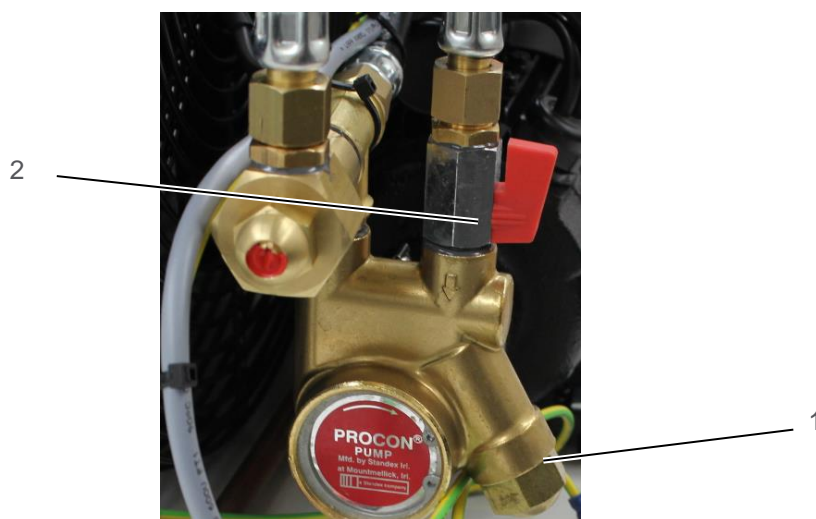

Fig. 12: Locations of ball valve and strainer

1	Strainer cover	2	Ball valve
---	----------------	---	------------

- 1) Disconnect the unit from mains.
- 2) Remove the side panel.
- 3) Close the ball valve.



CAUTION

A small amount of coolant will leak from the pump.

Use a cloth or an appropriate vessel for absorption.

- 4) Remove the strainer cover using a metric AF24 wrench.
- 5) Take off the strainer and clean it. In case of damage the strainer must be replaced.
- 6) Remount the strainer and screw on the cover.
- 7) Re-open the ball valve.
- 8) Should any coolant leak from the strainer the cover must be screwed on using a little more force.
- 9) Remount the side panel.



CAUTION

Risk of damage to the pump, if the unit is operated with a fully closed ball valve!

Never start the unit, when the ball valve is closed.

- 10) Start-up the unit for venting the cooling circuit (see page 22).
- 11) Check the coolant level and refill, if required.

9.5 Cleaning of Unit Casing



CAUTION

Risk of damage through use of improper cleansing material. When using aggressive or abrasive cleaning agents corrosion may occur as result of a damaged paint film.

- For cleaning the unit casing only use mild cleaning agents (e.g. dish washing detergents)!
- Use clean and lintless cloth for cleaning!

Regularly remove dirt from the casing of the unit to prevent corrosion damage and clogging of the air grids. Pay attention that all the plates at the unit are always clean and legible.

10. Repair

In case of malfunction during the warranty period the unit must be sent to the Laird Thermal Systems service department for repair (see page [7](#)). When warranty has expired, no restrictions from the side of Laird Thermal Systems exist with respect to repair work carried out by the customer as long as guarantee and warranty conditions remain untouched. In any case only expert staff is authorized for doing repair work.

NOTE

When doing repair work on the unit always be aware of the safety regulations as defined on page [9](#).

11. Dismounting, Disposal, Storage

11.1 Temporary Placing out of Operation

For placing the unit out of operation for maintenance or repair follows the steps below:

- Cooling operation is finished.
- 1) Disconnect the unit from mains.
- 2) Remove all cabling from the unit.
- 3) Remove all hoses to and from the unit.

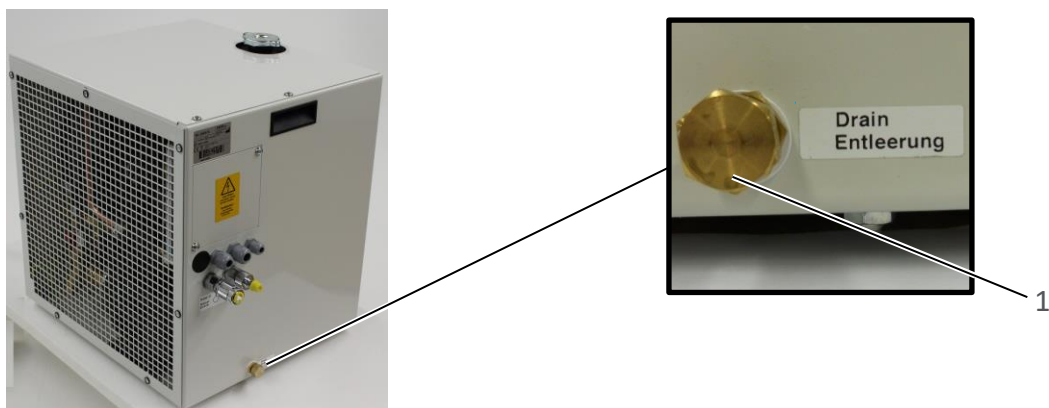

Fig. 13: Drain with cap

1	Cap
---	-----

NOTE

The coolant must be collected and disposed of according to valid regulations.

- 4) Let the coolant container run empty into an appropriate vessel.
 - 5) Clean the unit.
- ⇒ The unit is placed out of operation.

11.2 Re-packaging of the unit

- The unit has been emptied (see chapter [11](#)).
- 6) Lift the unit with a forklift or jack lift and place a transportable pallet under it.
- 7) Enclose the unit including the transportable pallet with shrinking foil and shrink the foil tight.
- ⇒ The unit is ready for transportation.

11.3 Storing the Unit

The storage area must be even and the unit should not stand on an edge or other obstructive object. The environmental conditions for storage of the unit or parts of it can be found in the specification paragraph on page [16](#).

11.4 Disposal

The unit was manufactured mainly from recyclable material.

Make sure the components of the unit end up at a qualified company for disposal and recycling.

Contact Laird Thermal Systems for take back of end-of-life units (see company contact on page [7](#) or ask a qualified company for disposal and recycling.

11.5 Disposal of Operating Materials

The operating materials of the unit can be hazardous to the environment and to health.

- Make sure the operating materials are disposed of or recycled according to local regulations.
- Also, the safety specifications of the coolant manufacturer must be obeyed.

11.6 Return of the unit to Laird Thermal Systems

NOTE

Declaration of decontamination

Before re-shipment of the unit a declaration of decontamination must be sent to Laird Thermal Systems.

12. Wear Parts and Spare Parts

Spare parts must comply with the technical specifications defined by Laird Thermal Systems. Original Laird Thermal Systems parts are subject to strict obligations and fulfill these requirements.

Laird Thermal Systems does not provide warranty service in case of damages caused by the use of spare parts made by manufacturers other than Laird Thermal Systems.

NOTE

Identification data concerning the unit and spare parts

The type of unit and the article number can be found on the identification plate of the unit. The corresponding numbers in Fig. 12 as well as the part descriptions are listed in the spare part list.

Please direct your inquiries and orders to Laird Thermal Systems (contact see page [7](#)) with the following detailed information

- Type of unit
- Article number
- Serial number
- Part description
- Quantity
- Shipping details

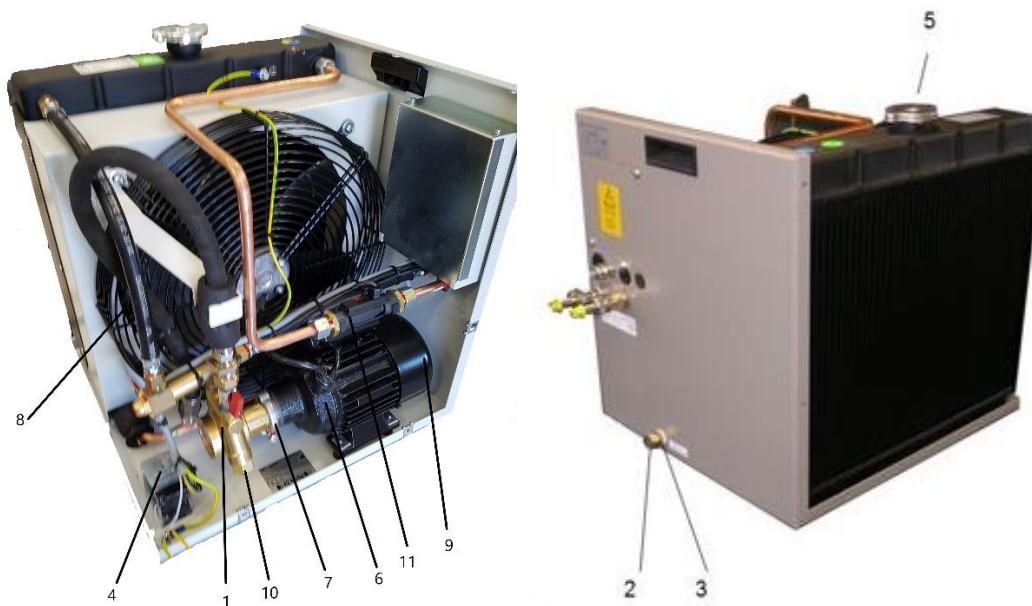

Fig. 14: Spare parts overview

Pos.	Qty	Description	Item No.
1	1	Pump	2113.00
2	1	Drain cap	2131.00
3	1	Thermostat	2126.00
4	1	Spare CAP - heat exchanger	2075.00
5	1	Motor	2001.00
6	1	Flexible coupling	2038.00
7	1	Fan	2112.00
8	1	Capacitor for fan	2088.00
9		Strainer (inside pump casing)	2081.00
10	1	Flow control device	2031.00

10. Spare parts

Addendum

Flow scheme

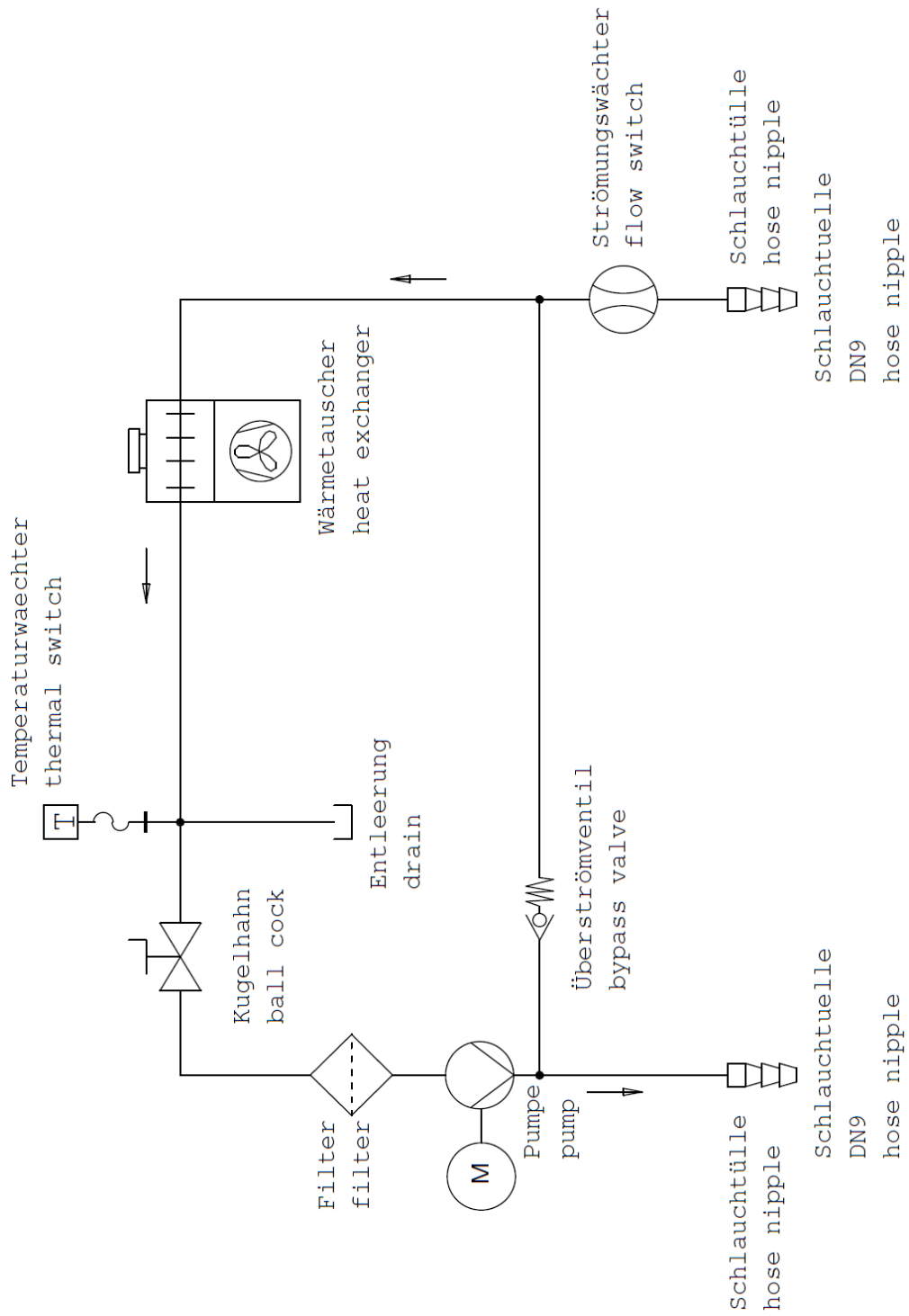

Wiring diagram

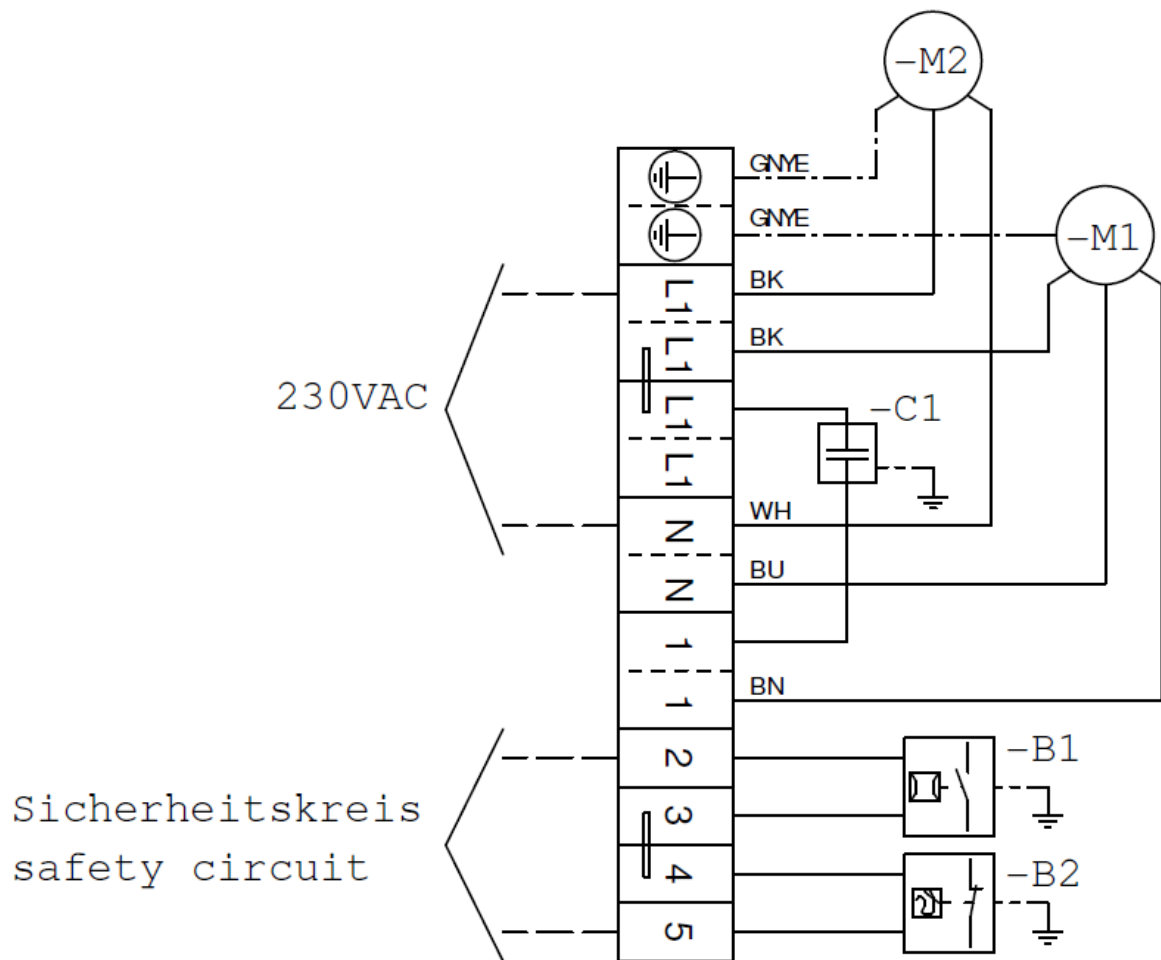

B1 Strömungswächter / flow switch

B2 Temperaturwächter / thermal switch

C1 Kondensator / capacitor

M1 Lüfter / fan

M2 Pumpe / pump